

Date rev. Description

V 1.0

House	2812000	Sheet	1
-------	---------	-------	---

Drawing	3D	Scale	
---------	----	-------	--

Material	28X135	Date	16.05.2022
----------	--------	------	------------

Drawer	K.K.	File	2812000 3D.dwg
--------	------	------	----------------

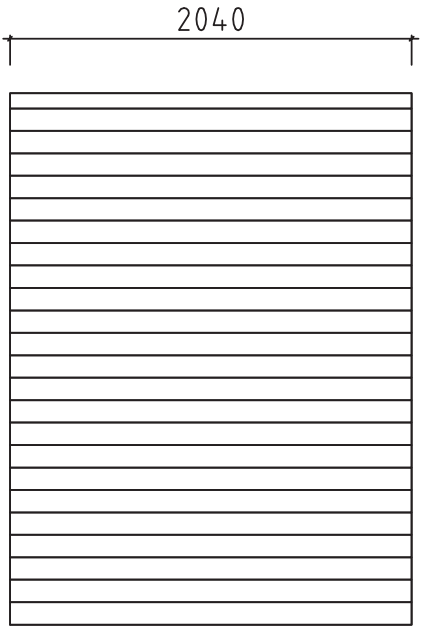
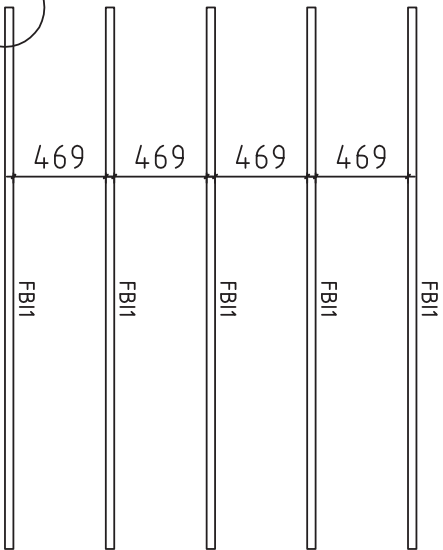
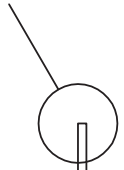
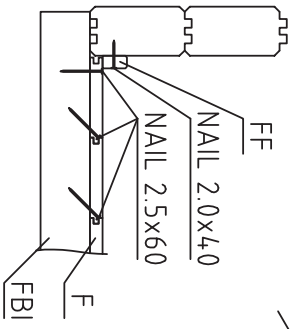

House	2812000	Sheet	2
Drawing	FLOORBEAMS	Scale	1:35
Material	4.3x4.3	Date	16.05.2022
Drawer	K.K.	File	2812000.dwg

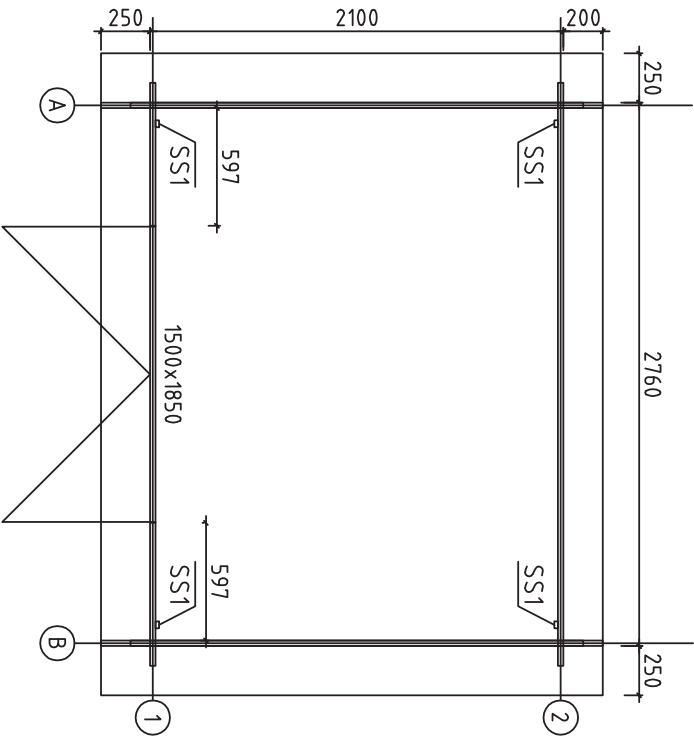



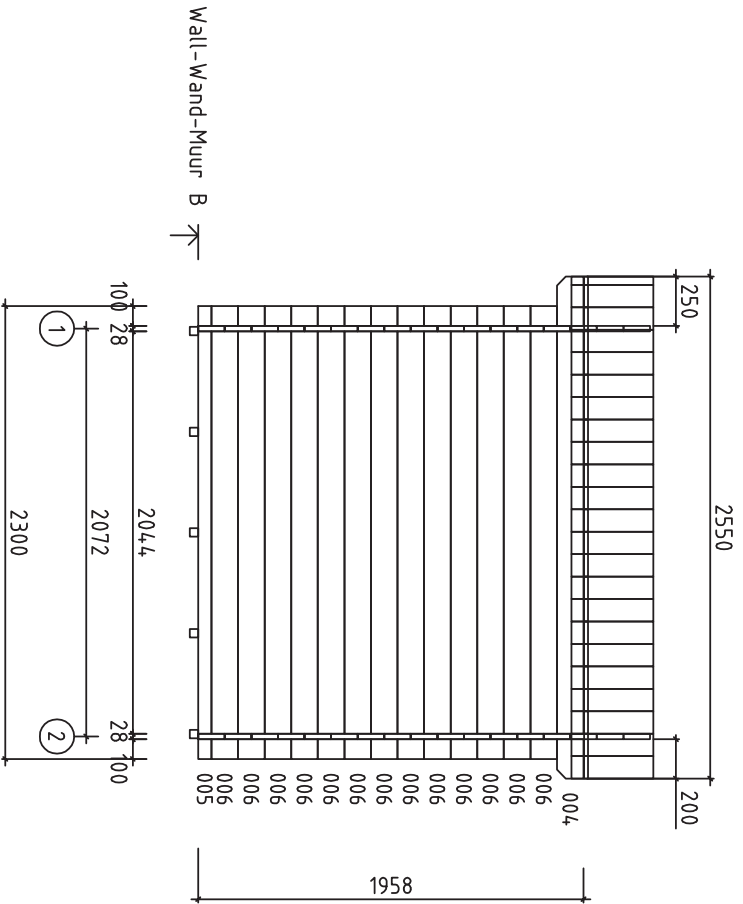



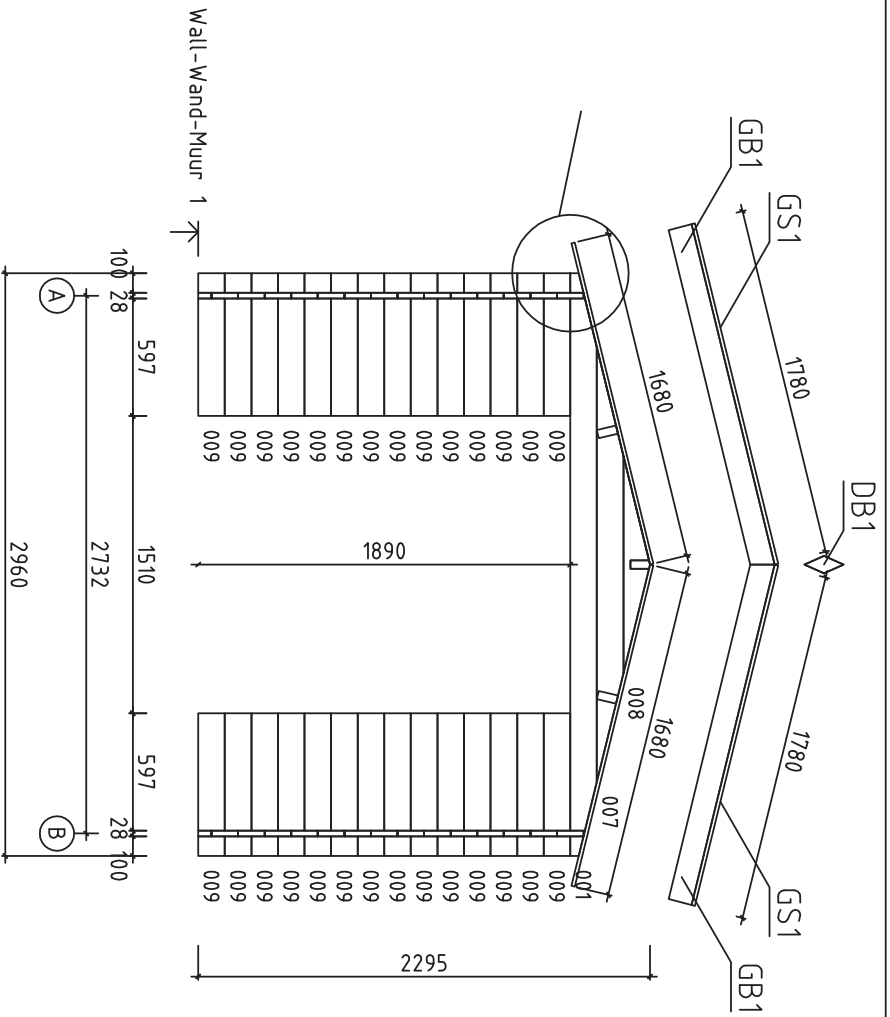
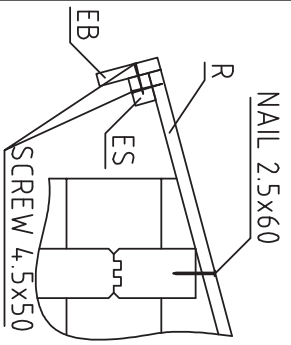



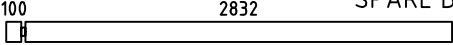
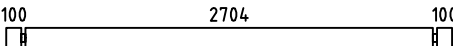
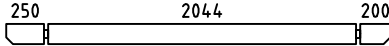
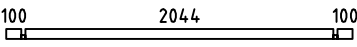
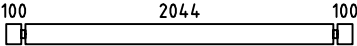
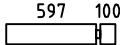
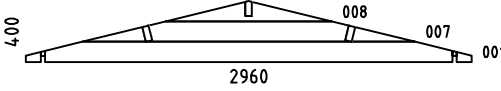
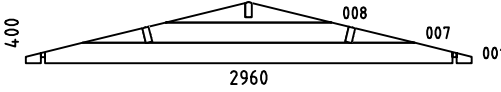

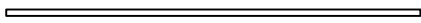
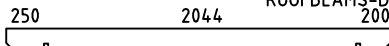
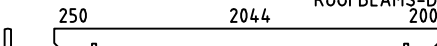

House	2812000	Sheet	3
Drawing	Plan	Scale	1:35
Material	28x135	Date	16.05.2022
Drawer	K.K.	File	2812000.dwg

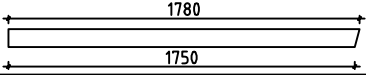









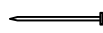

House	2812000	Sheet	5
Drawing	WALL-WAND-MUUR B	Scale	1:35
Material	2.8x13.5	Date	16.05.2022
Drawer	K.K.	File	2812000.dwg

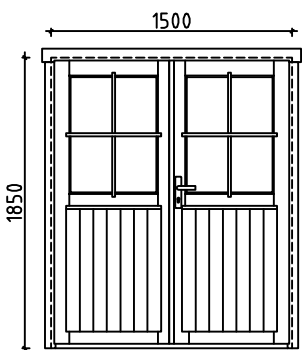

House	2812000	Sheet	6
Drawing	WALL-WAND-MUUR 1	Scale	1:35
Material	2.8x13.5	Date	16.05.2022
Drawer	K.K.	File	2812000.dwg

Pos	Specification-Bestimmung-Omschrijving 2812000	Pcs	Profile (mm)	L (mm)		
002	100 2832 SPARE BEAM-ERZATZBOHLE-VOORRAADPLANK 	1	28x135	2960		
003	100 2704 100 	14	28x135	2960		
004	250 2044 200 PM 	2	28x135	2550		
005	100 2044 100 	2	28x68	2300		
006	100 2044 100 	26	28x135	2300		
009	597 100 	28	28x135	725		
W1-1		1	28x400	2960		
W2-1		1	28x400	2960		
HB	HIT BLOCK-SCHLAGHÖLZER-BLAZENPLANK 	2	28x135	300		
FBI1	FLOORBEAMS-FUSSBODENBALKEN-POUTRES DE FONDATION IMPRÉGNÉS  IMM	5	43x43	2750		
RB1	250 2044 200 ROOFBEAMS-DACHBALKEN-DAKBALK 	2	43x140	2550		
RB2	250 2044 200 ROOFBEAMS-DACHBALKEN-DAKBALK 	1	43x140	2550		
F1	FLOORBOARD-FUSSBODENBRETT-PLANCHER  or-oder-ou	32+1 24+1	18x88 18x114	2040		
R1	ROOFBOARD-DACHBRETT-DAKPLANK  or-oder-of	60+1 46+1	18x88 18x114	1680		
FF1	FLOOR FILLET-FUSSBODENLEISTE-BAGUETTE DE FINITION DE PLANCHER 		18x35	9.5		
GB1	GABLE BOARD-GIEBELBLENDE-GEVELPLANK 	4	18x120	1780		
GS1	ROOF FELT FILLET-GIEBELLEISTE-GEVELLIJST 	4	18x70	1780		
EB1	EAVE BOARD-TRAUFBRETT-AFDEKPLANK 	2	18x90	2550		
ES1	EAVE SLAT-TRAUFENLEISTE-AFDEKLIJST 	2	30x40	2550		
DB1	DIAMOND-RAUTE-DIAMANT 	2	18x90	200		
SS1	STORM SLAT-STURMLEISTE-STORMLIJST 	4	18x35	1790		
	SCREWS-SCHRAUBEN-SCHROEF FOR-FÜR-VOOR SS1 	12	φ6.0	45		
	WASHER-SCHEIBE-SCHIJF FOR-FÜR-VOOR SS1 	12	φ6.0	18		
Kood	2812000	Material	File	2812000.dwg	Leht	8

Pos	Specification-Bestimmung-Omschrijving 2812000		Pcs	Profile (mm)	L (mm)
	NAIL-NAGEL-CLOUS FOR-FÜR-POUR FF1		32	∅2.0	40
	NAIL-NAGEL-NAGEL FOR-FÜR-VOOR R1, F1		350	∅2.5	60
	SCREWS-SCHRAUBEN-SCHROEF FOR-FÜR-VOOR GB1, GS1, EB1, ES1, DB1		76	∅4.5	50
	SCREWS-SCHRAUBEN-VIS 003, 2x009 FOR-FÜR-POUR		20	∅4.5	90
	SCREWS-SCHRAUBEN-SCHROEF FOR-FÜR-VOOR RB1, RB2		6	∅6.0	160
	DOUBLEDOR-DOPPELTÜR-DUBBELE DEUR (right-rechts-rechts) AST_PL		1	1500	1850
			1		
			1		
			1		
			1		
			6		
			2		
Kood	2812000	Materjal	File	2812000.dwg	Leht 9