

Techn. Data / Daten: Garage Rauma

Log length (W x D): 836 x 415 cm

Bohlenaußenmaß (B x T): 836 x 415 cm

Wall size(outside): 816 x 395 cm · Log thickness: 40 mm

Wandaußenmaß: 816 x 395 cm · Bohlenstärke: 40 mm

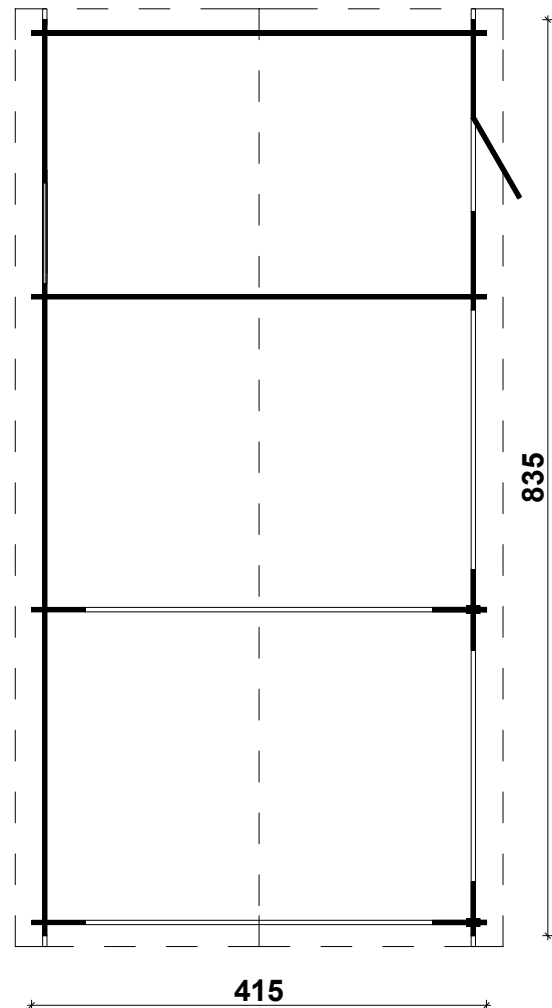
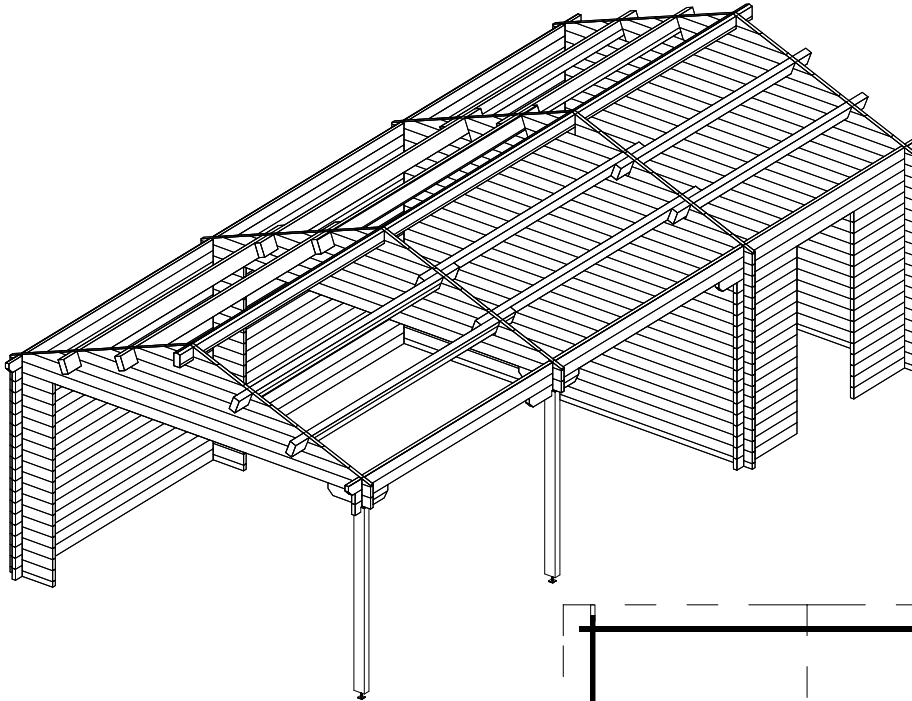

Note: All dimensions are approximate !
Achtung : Alle angegebenen Maße sind ca. - Maße !

Garage Rauma 40 mm / 836 x 415 cm

Ground plan / Wandplan

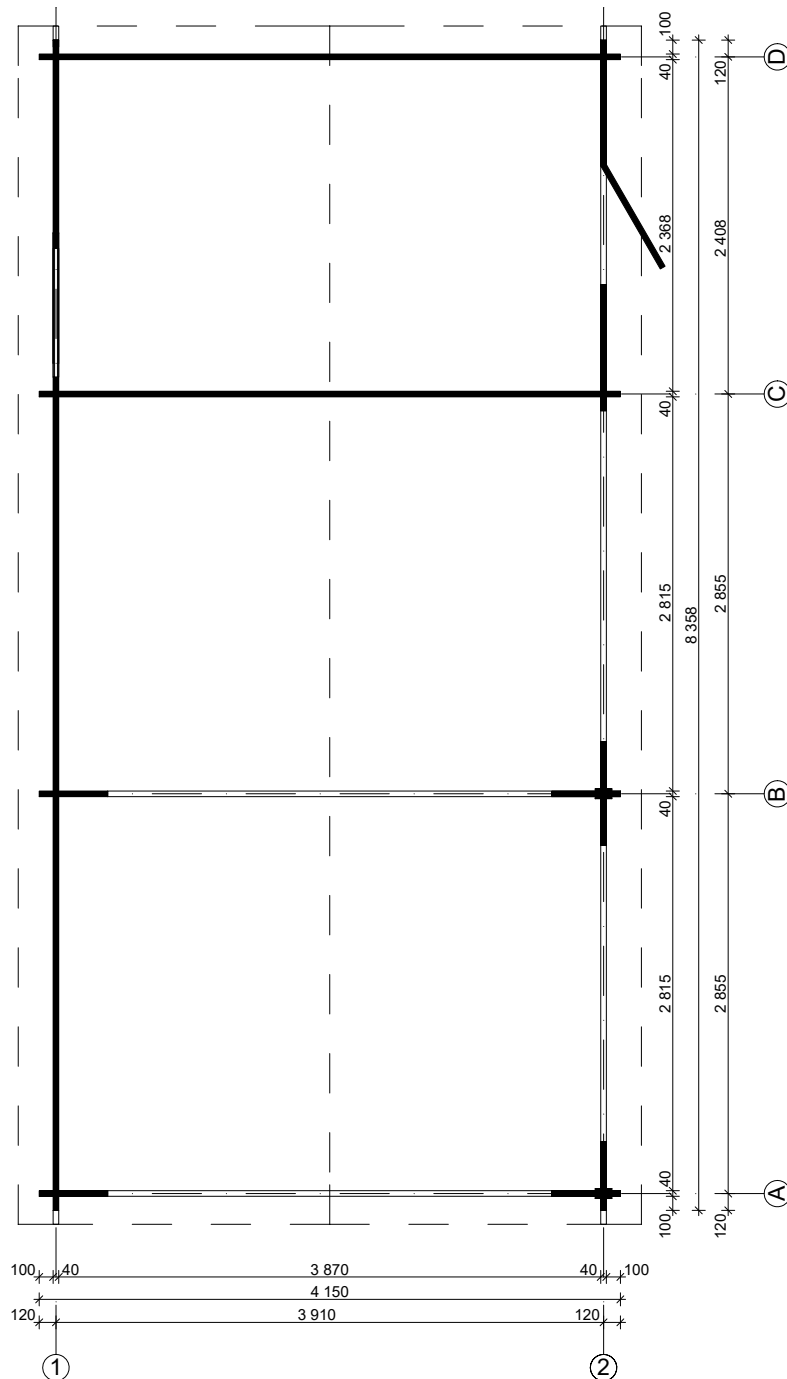

Garage Rauma 40 mm / 836 x 415 cm

Foundation joist / Fundamentplan

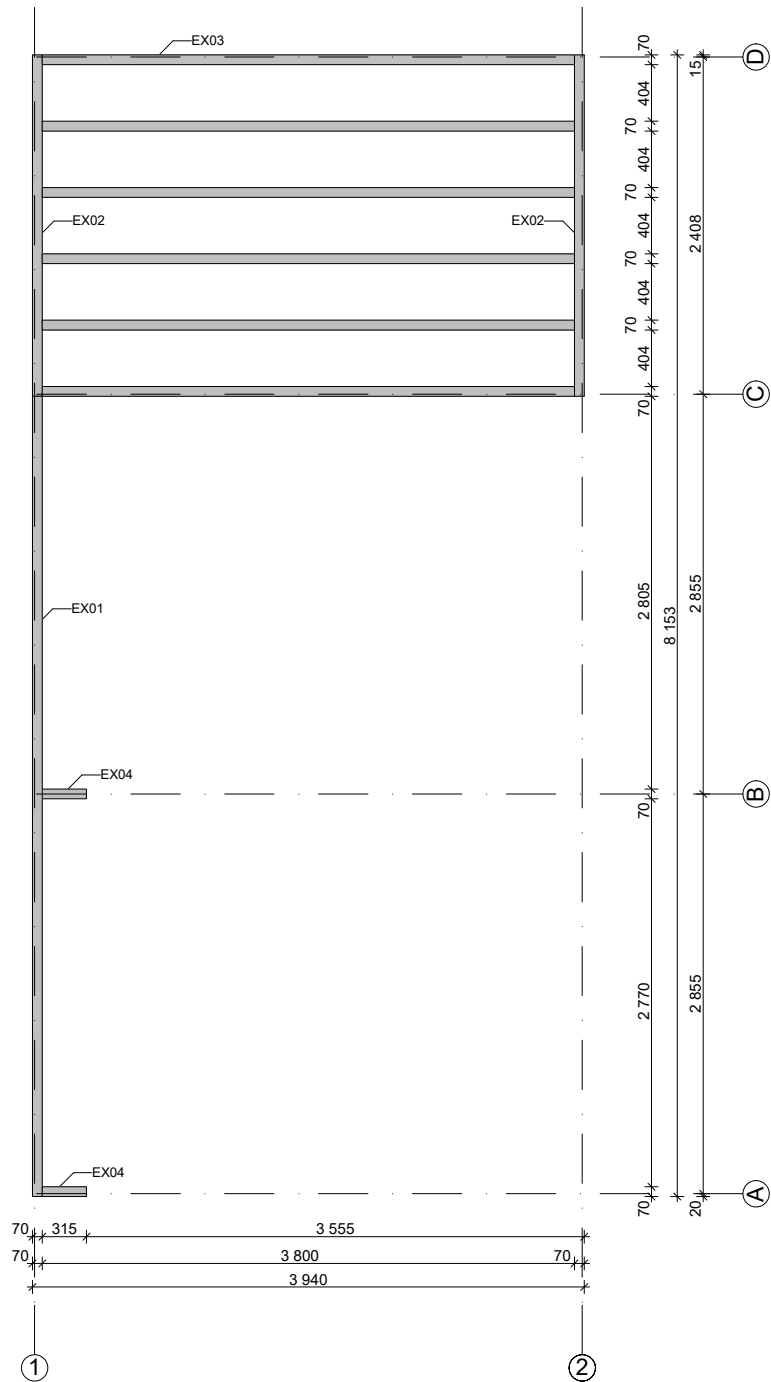

Garage Rauma 40 mm / 836 x 415 cm - A

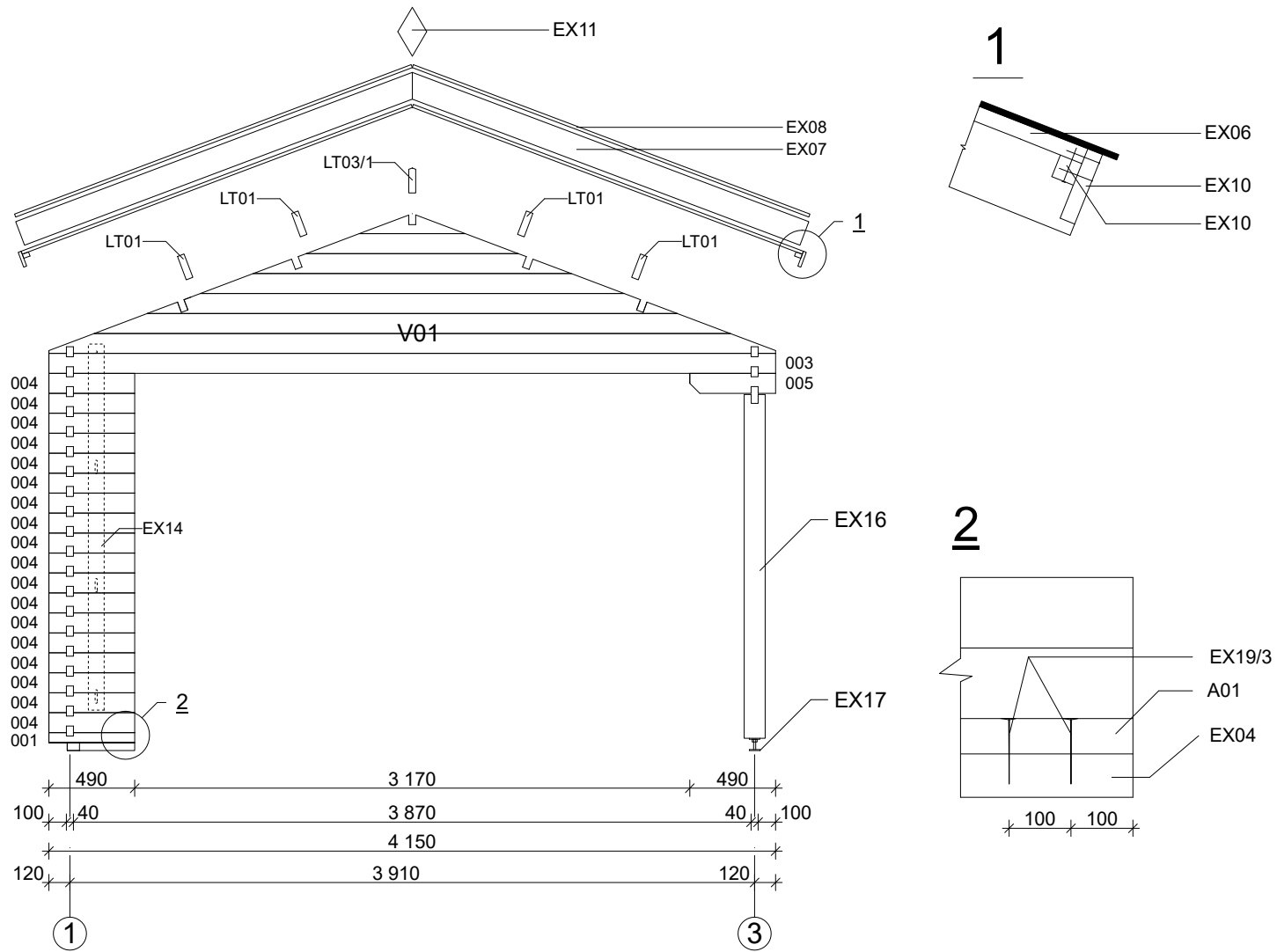

Garage Rauma 40 mm / 836 x 415 cm - B

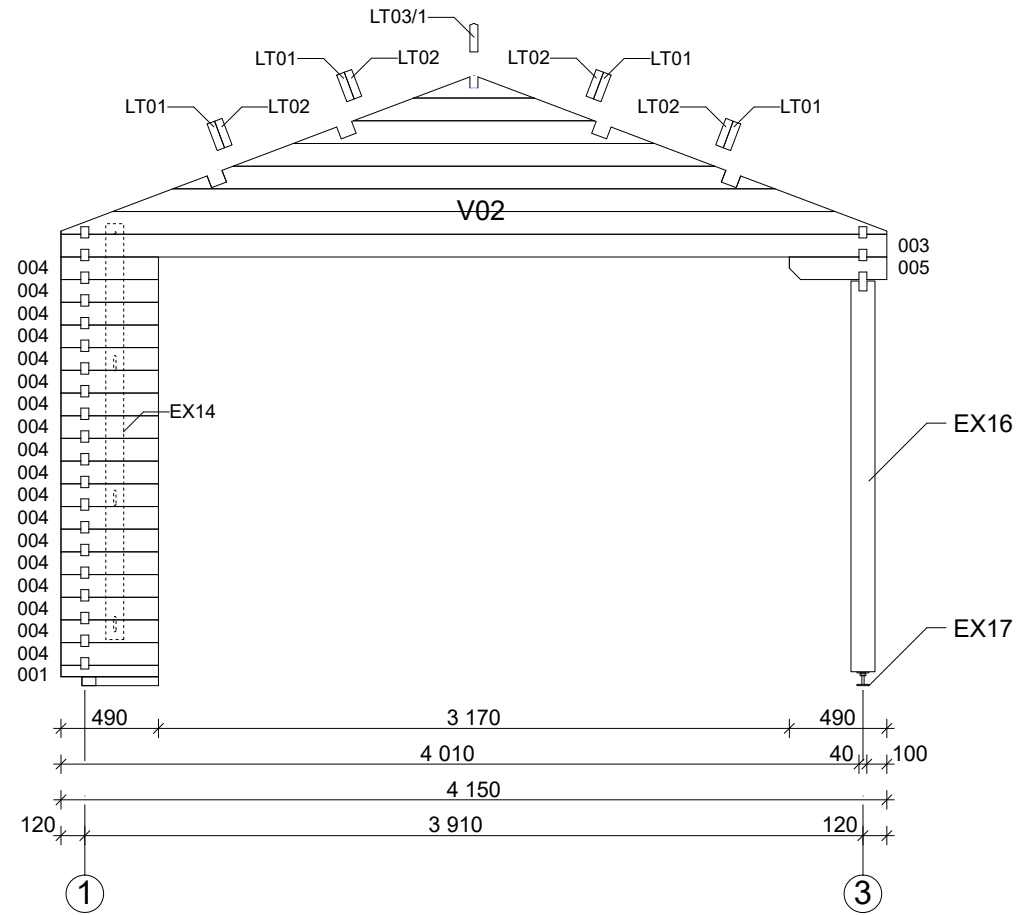

Garage Rauma 40 mm / 836 x 415 cm - C

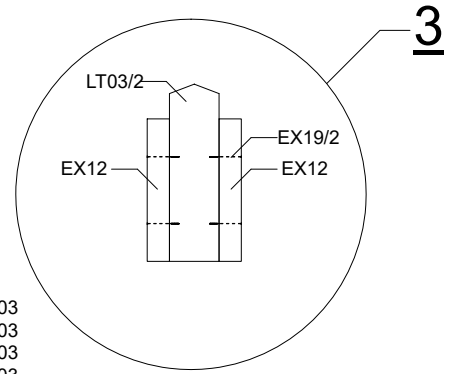
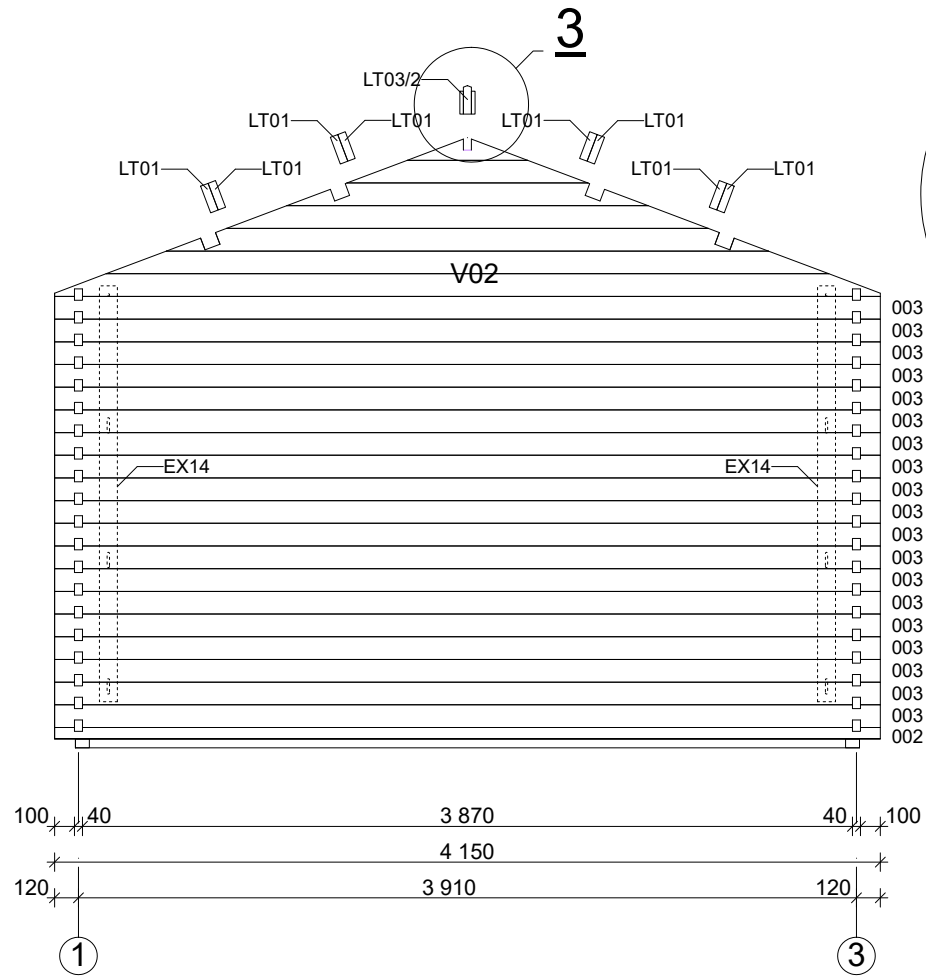



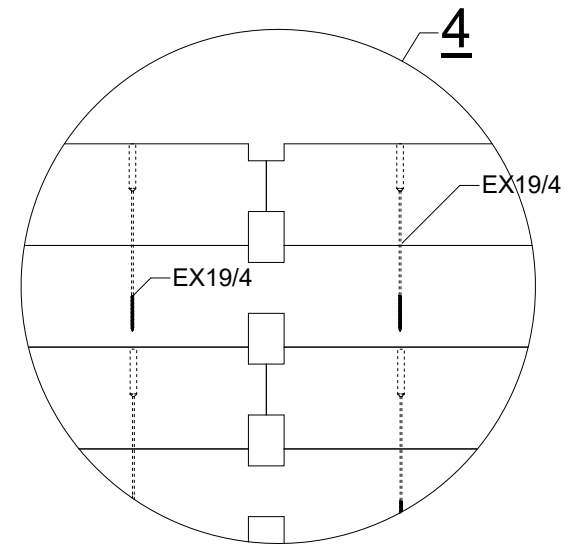
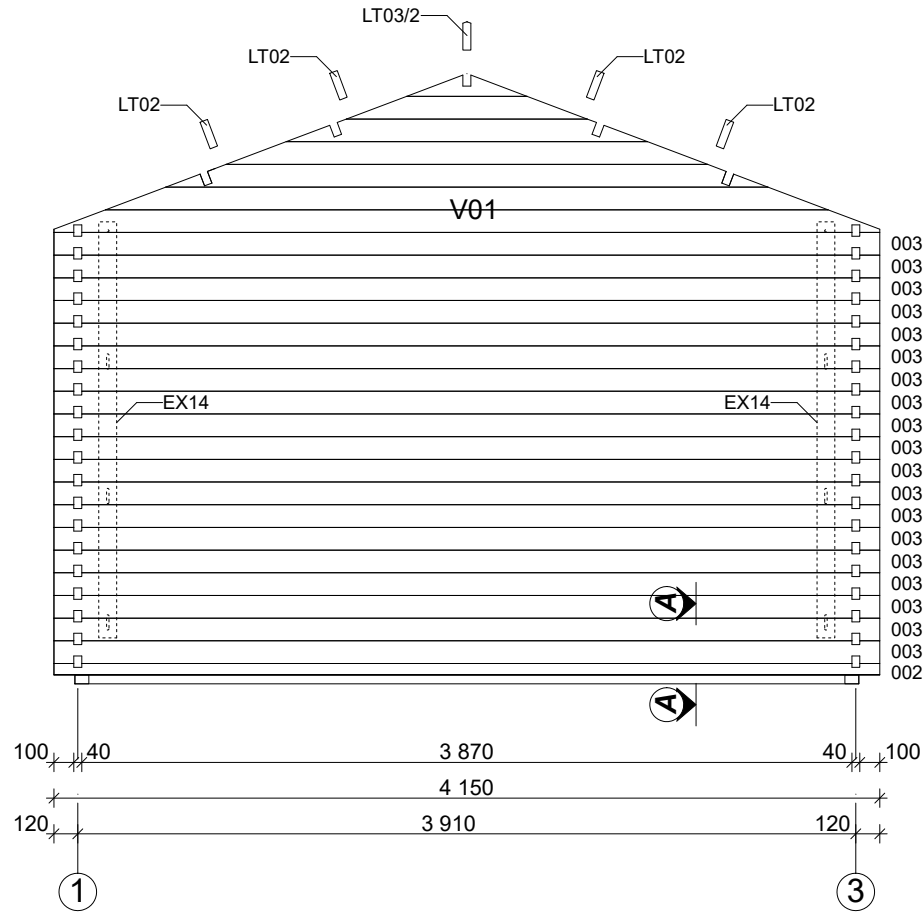



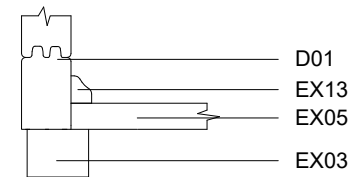







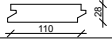
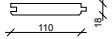
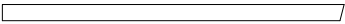
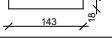
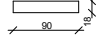
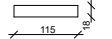
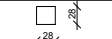

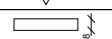
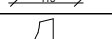
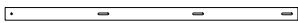
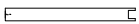
Garage Rauma 40 mm / 836 x 415 cm - D

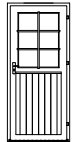
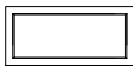

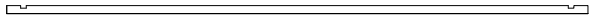
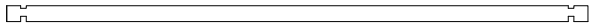
A-A

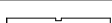

Garage Rauma 40 mm / 836 x 415 cm - Specification / Teileliste

Nr.		 mm	 mm	 x
EX01	Foundation beams / Fundamenthölzer	45 x 70	5715	1
EX02			2438	2
EX03			3800	6
EX04			315	2
EX05	Floor boards / Fußbodenbretter		2364	36+1
EX06	Roof boards / Dachbretter		2420	156+2
EX07	Fascia board / Giebelblende 		2460	4
EX08	Giebelabschlussbrett		2460	4
EX09	Eave edging / Traufenbrett		4279	4
EX10	Eave edging slat / Traufenleiste		4279	4
EX11	Diamond / Raute			2
EX12	Exterior- and interior trim		2813	2
EX13	Baseboard / Fußleisten		ca. 12,4m	
EX14	Storm brace / Sturmleisten 	40 x 90	2090	6
EX15			--	--
EX16	Post / Pfoste 	70x120	1965	2
EX17	Adjustable postfoot / Stütze	s 		2
EX18	Nut, washer / Mutter, Scheibe M 8 x 90,			24
EX19	Screws / Schrauben 4,0 x 40; 4,0 x 50; 5,0 x 100; 6,0 x 140		40/870/40/70	
EX20	Nails / Nägel 1,4 x 35		50	
EX21	Schlaghölzer	40 x 114	300-400	
EX22	Door / Einzeltür 840 x 1900 mm - 40 mm - R STANDART +			1
EX23	Fixed window / fenst. 915 x 420 mm - 40 mm STANDART +			1
EX24	Roofing felt / Dachpappe		--	--
001			490	2
002			4150	2
003			4150	40
004			490	36
005			490	3
006			740	1
007			899	34

