

House 2827980

Sheet 1

Drawing 3D

Scale

Material 28x135

Date 06.03.2024

Drawer RP

File 2827980_3D.dwg

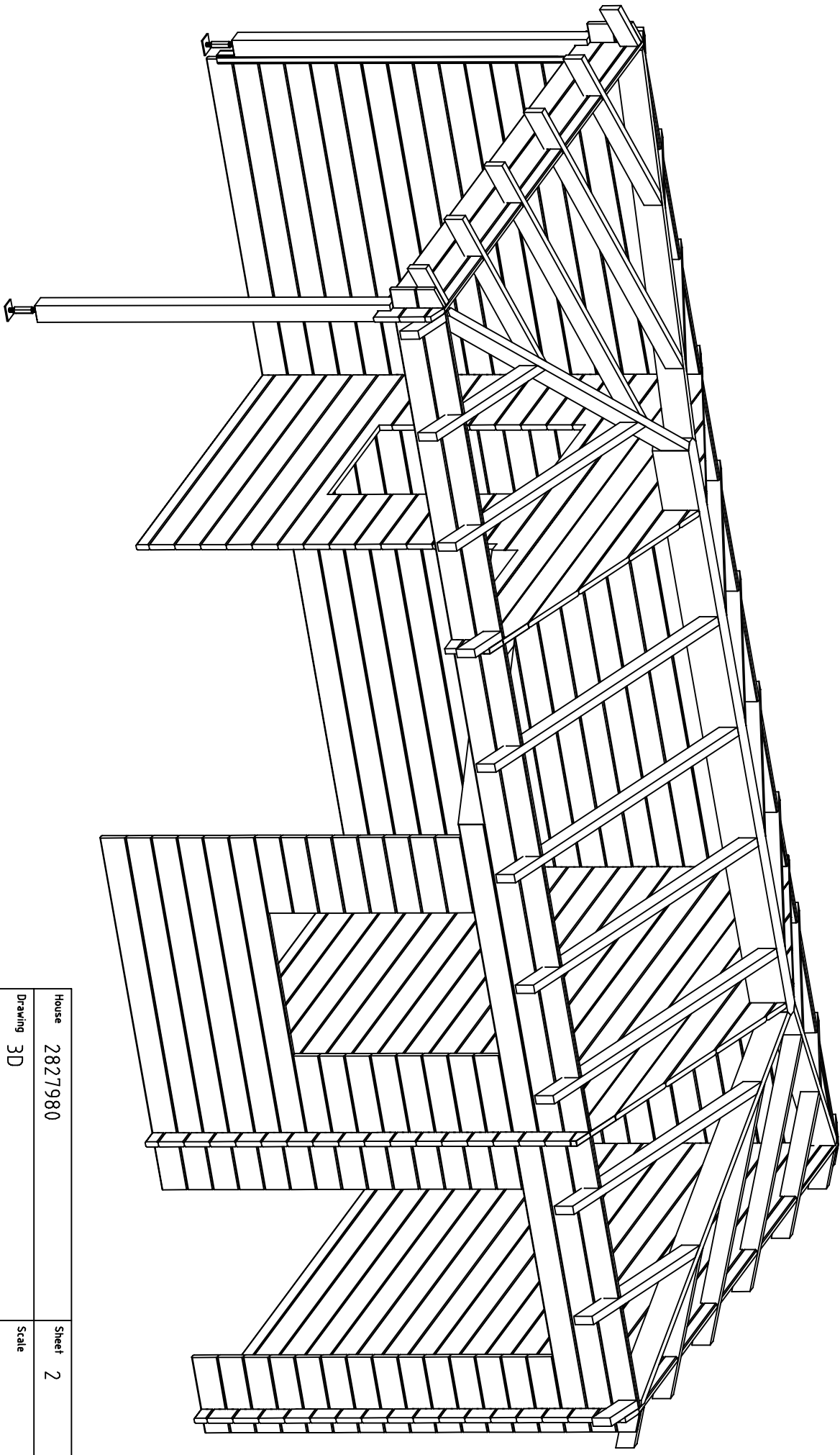

House	2827980	Sheet	2
Drawing	3D	Scale	
Material	28x135	Date	06.03.2024
Drawer	RP	File	2827980_3D.dwg

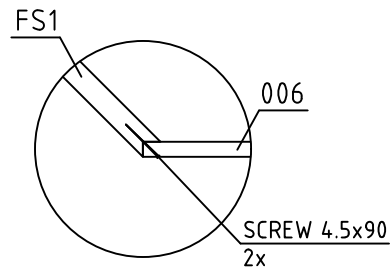
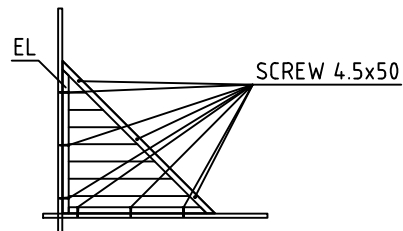
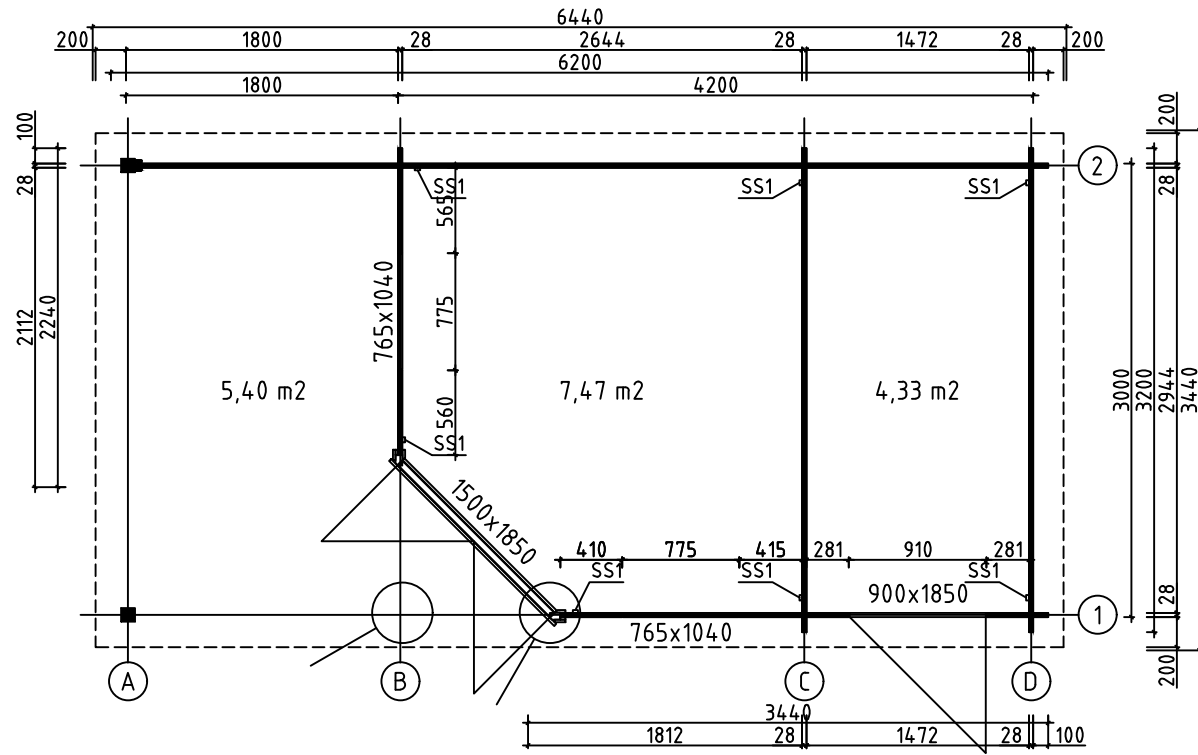

House	2827980	Sheet	3
Drawing	GRUNDPLAN-GRUNDPLAN-PLAN	Scale	1:50
Material	28x135	Date	06.03.2024
Drawer	RP	File	2827980.dwg

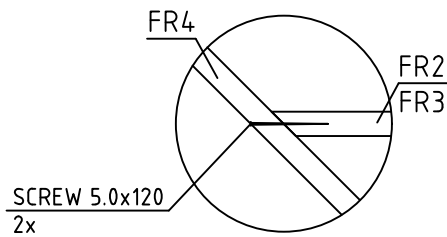
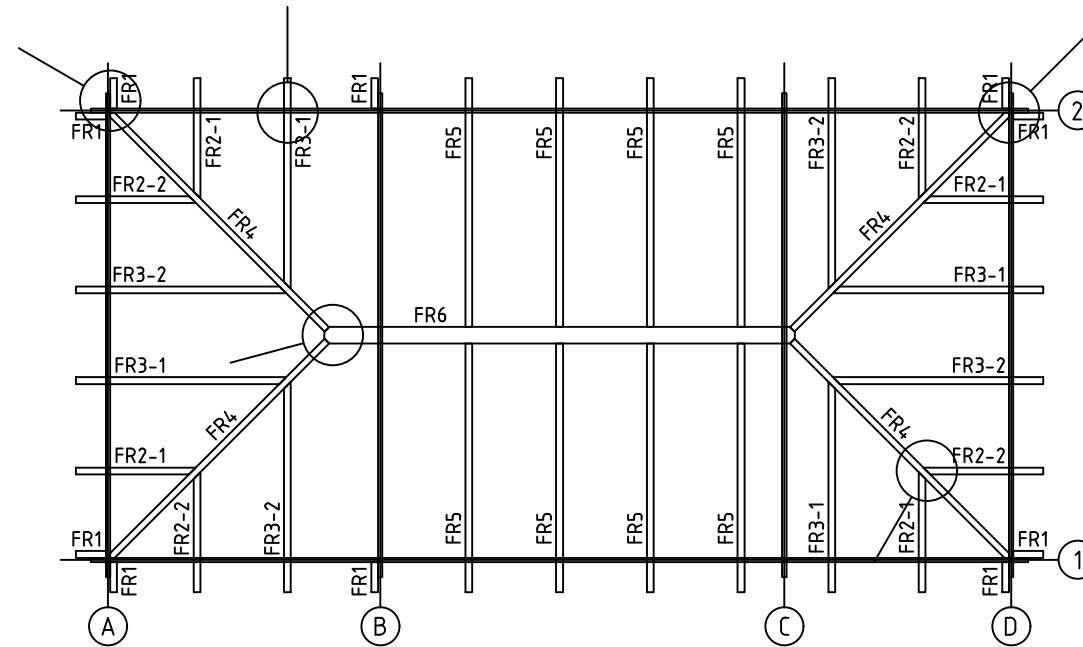
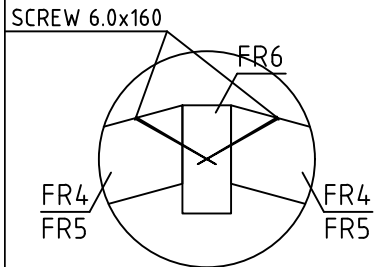
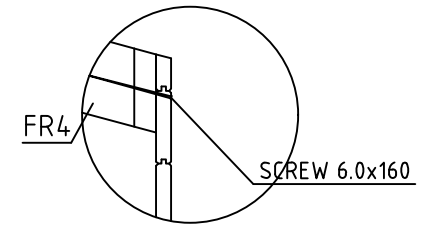
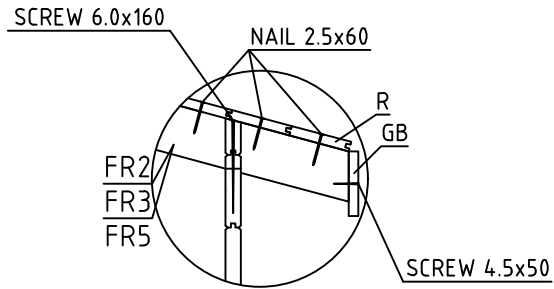
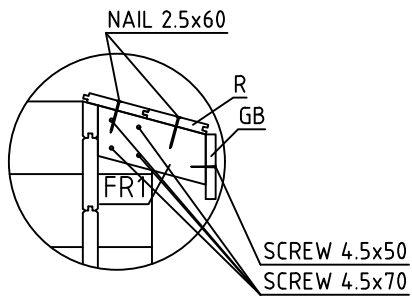

House	2827980	Sheet	4
Drawing	ROOFBEAMS-DACHBALKEN-DAKBALK	Scale	1:50
Material	43x140, 45x90	Date	06.03.2024
Drawer	RP	File	2827980.dwg

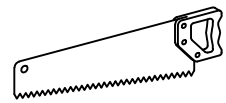
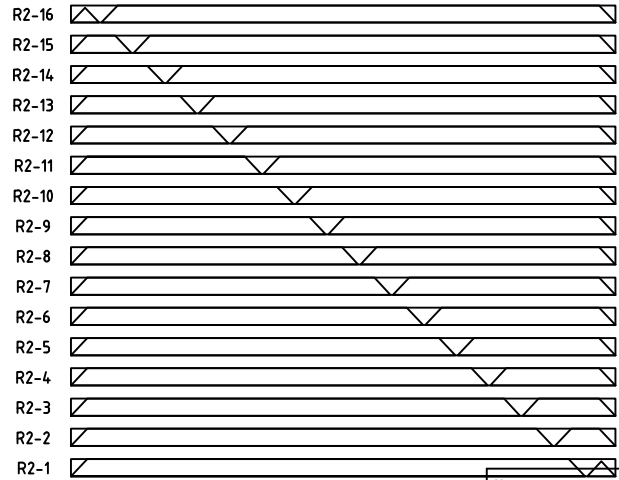
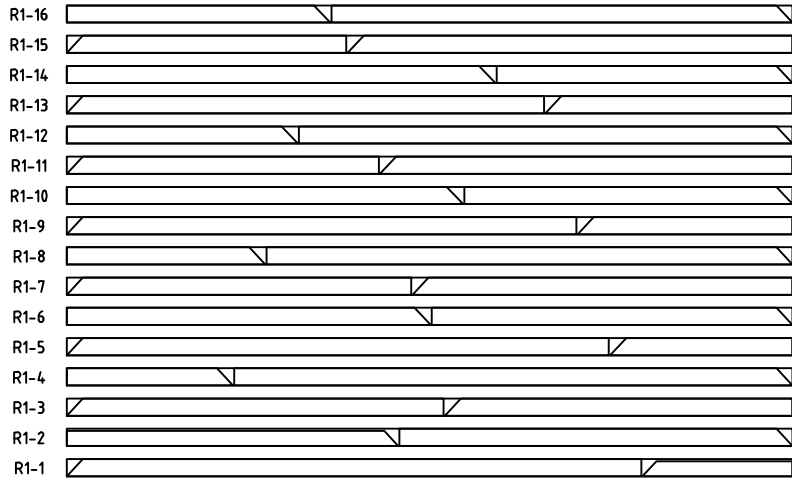
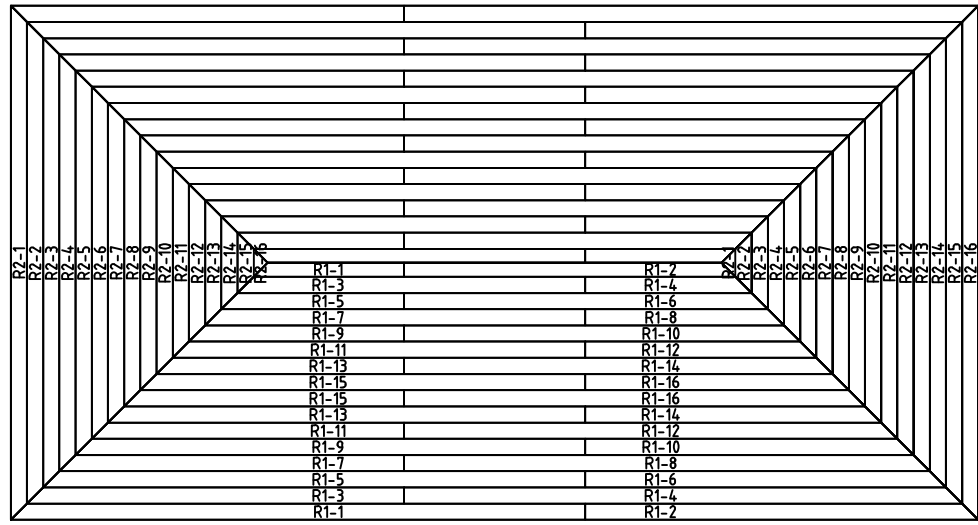

House	2827980	Sheet	5
Drawing	ROOFBOARD-DACHBRETT-DAKPLANK	Scale	1:50
Material	18x114	Date	06.03.2024
Drawer	RP	File	2827980.dwg

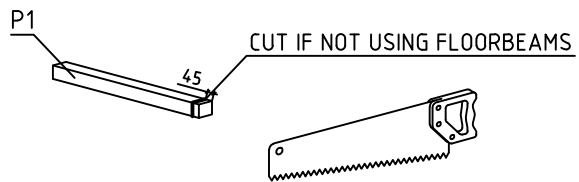
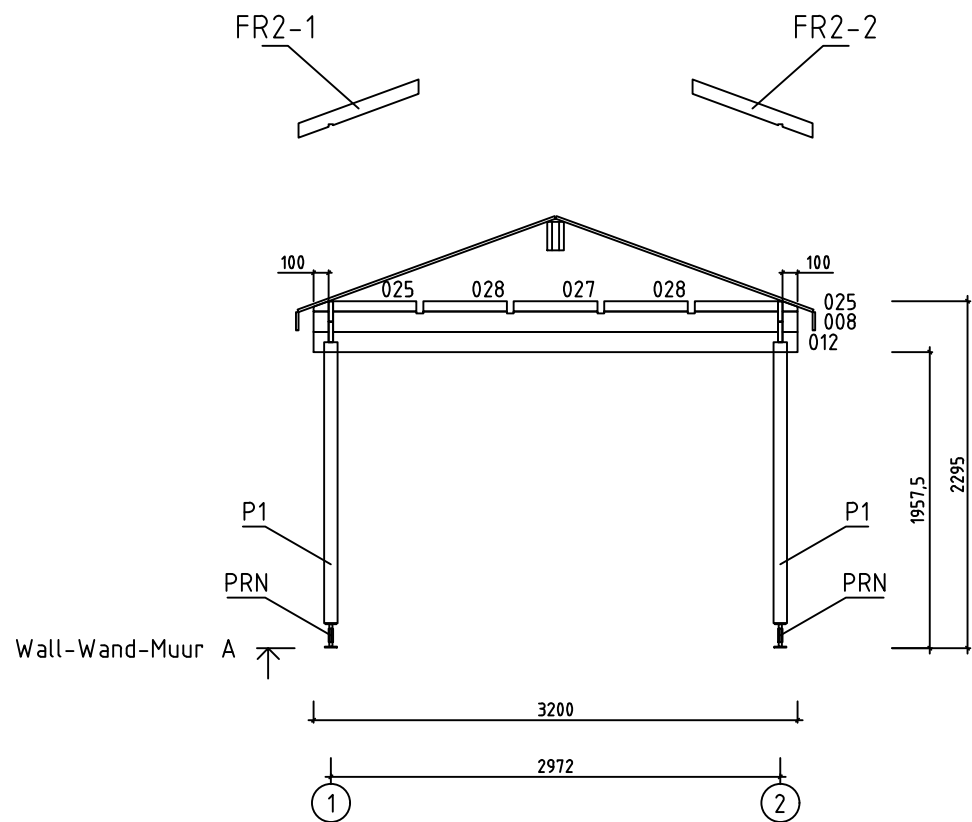

House	2827980	Sheet	6
Drawing	WALL-WAND-MUUR A	Scale	1:50
Material	28x135	Date	06.03.2024
Drawer	RP	File	2827980.dwg

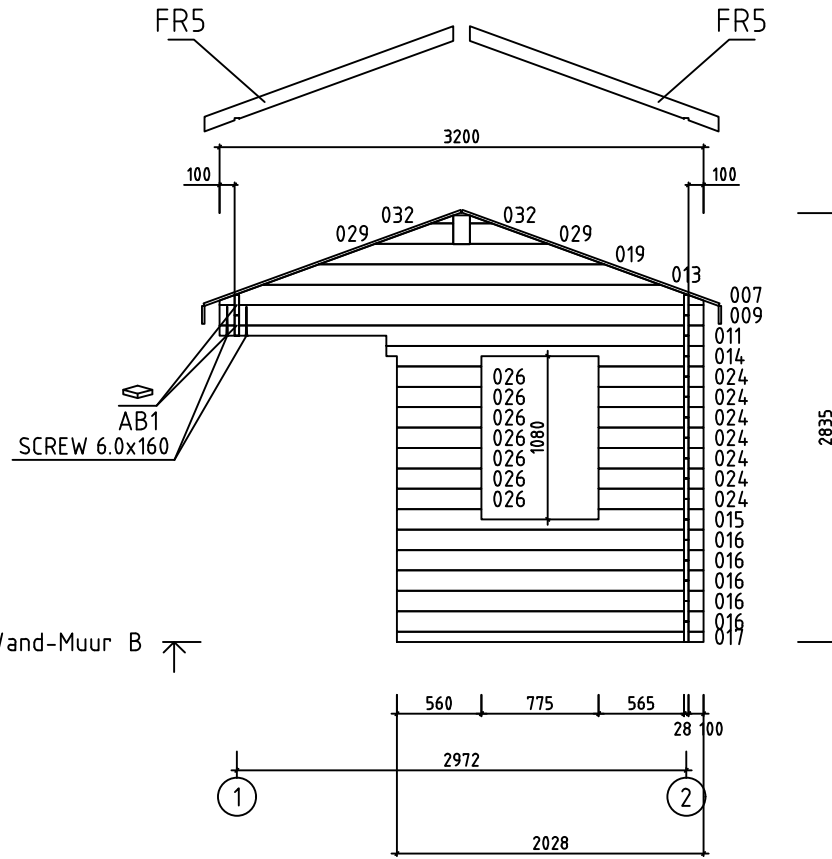

Wall-Wand-Muur B ↗

House	2827980	Sheet	7
Drawing	WALL-WAND-MUUR B	Scale	1:50
Material	28x135	Date	06.03.2024
Drawer	RP	File	2827980.dwg

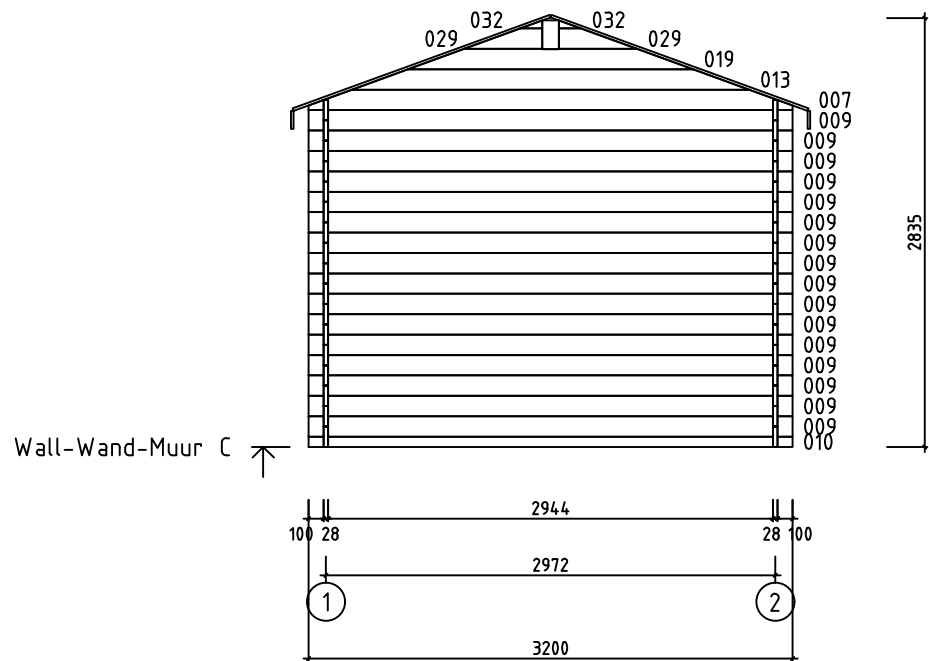

House	2827980	Sheet	8
Drawing	WALL-WAND-MUUR C	Scale	1:50
Material	28x135	Date	06.03.2024
Drawer	RP	File	2827980.dwg

FR1



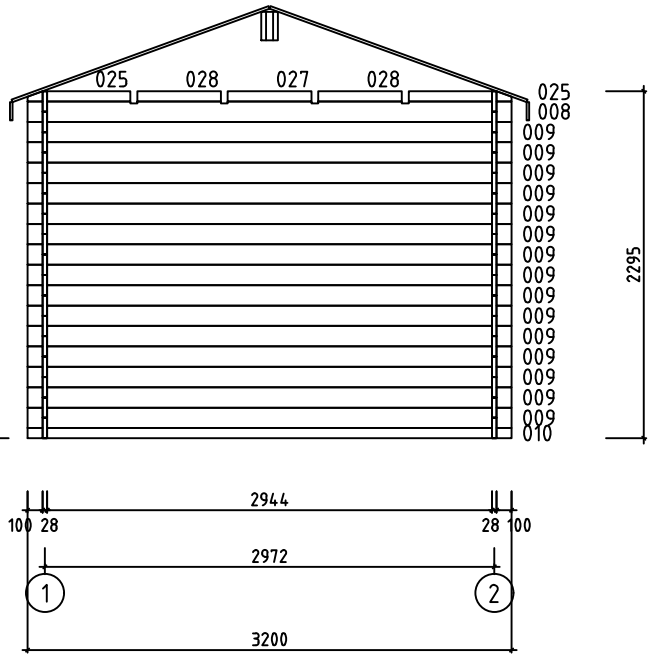

FR1





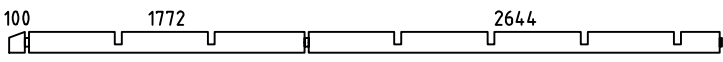
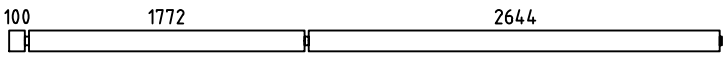
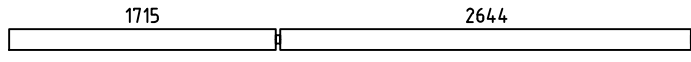
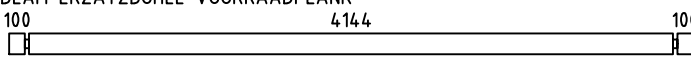
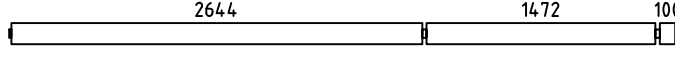
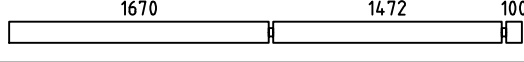
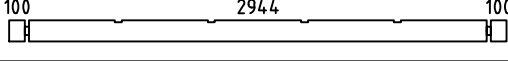
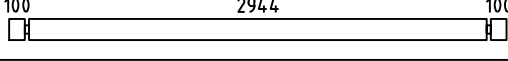
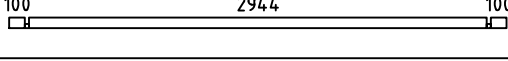
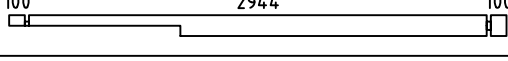
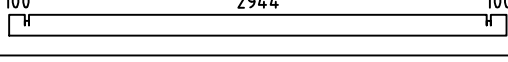
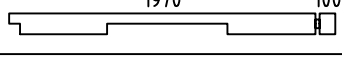
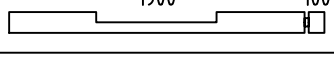
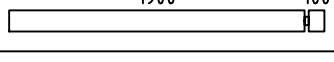
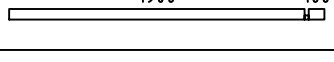
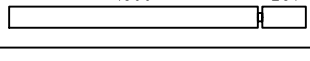
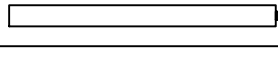
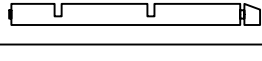
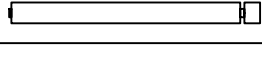
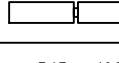
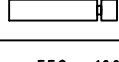
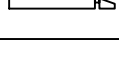







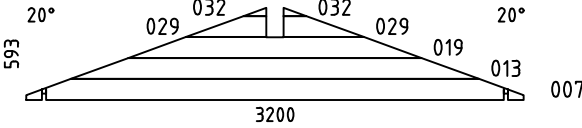

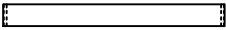
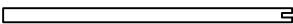
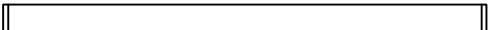
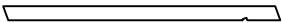
Wall-Wand-Muur D

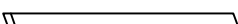
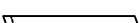

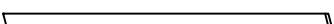





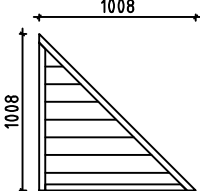



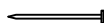

2295

House	2827980	Sheet	9
Drawing	WALL-WAND-MUUR D	Scale	1:50
Material	28x135	Date	06.03.2024
Drawer	RP	File	2827980.dwg

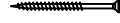
Pos	Specification-Bestimmung-Omschrijving	Pcs	Profile (mm)	L (mm)
001		PM 2	28x135	4586
002		2	28x135	4586
003		7	28x135	4401
004	SPARE BEAM-ERZATZBOHLE-VOORRAADPLANK 	1	28x135	4400
005		8	28x135	4286
006		1	28x135	3298
008		2	28x135	3200
009		32	28x135	3200
010		2	28x68	3200
011		1	28x135	3200
012		1	28x135	3200
014		1	28x135	2098
015		1	28x135	2028
016		5	28x135	2028
017		1	28x68	2028
018		6	28x135	1909
020		8	28x135	1729
021		PM 2	28x135	1614
022		9	28x135	1614
023		8	28x135	724
024		7	28x135	693
025		4	28x68	680
026		7	28x135	560
027		2	28x68	555
028		4	28x68	553
House 2827980		Material		File 2827980.dwg
			Sheet	12

Pos	Specification-Bestimmung-Omschrijving	Pcs	Profile (mm)	L (mm)		
030		8	28x135	410		
031	281 100 	14	28x135	409		
WB-1 WC-1		2	28x593	3200		
HB	HIT BLOCK-SCHLAGHÖLZER-BLAZENPLANK 	2	28x135	300		
FS2	FIXING SLAT-BEFESTIGUNGSLEISTE-BEVESTIGING PLINT 	1	45x70	1960		
FS1	FIXING SLAT-BEFESTIGUNGSLEISTE-BEVESTIGING PLINT 	1	43x140	1425		
P1	POST-PFOSTEN-STUT 	2	90x90	1905		
FR6	ROOFBEAMS-DACHBALKEN-DAKBALK 	1	110x190	3110		
FR5	RAFTER-SPARREN-DAKSPAR 	8	45x90	1783		
FR3-1	RAFTER-SPARREN-DAKSPAR 	4	45x90	1514		
FR3-2	RAFTER-SPARREN-DAKSPAR 	4	45x90	1514		
FR2-1	RAFTER-SPARREN-DAKSPAR 	4	45x90	878		
FR2-2	RAFTER-SPARREN-DAKSPAR 	4	45x90	878		
FR1	RAFTER-SPARREN-DAKSPAR 	10	45x90	245		
FR4	RAFTER-SPARREN-DAKSPAR 	4	43x140	2129		
R1	ROOFBOARD-DACHBRETT-DAKPLANK  or-oder-of	32+2 42+2	18x114 18x88	4800		
R2	ROOFBOARD-DACHBRETT-DAKPLANK  or-oder-of	16+2 21+2	18x114 18x88	3600		
GB1	GABLE BOARD-GIEBELBLENDE-GEVELPLANK 	2	18x120	3420		
GB2	GABLE BOARD-GIEBELBLENDE-GEVELPLANK 	4	18x120	3210		
AB1	ASSEMBLING BOARD-MONTAGE BOARD-MONTAGE PLANK 	2	15x20	20		
EL	ELEMENT-ELEMENTE-ELEMENTEN 	1	48x1008	1008		
House	2827980	Material	File	2827980.dwg	Sheet	13

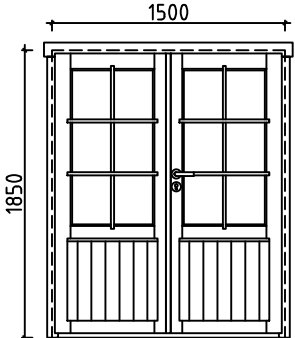
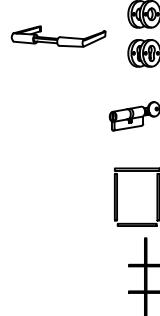
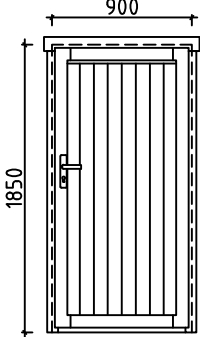
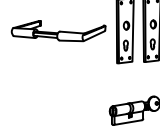
Pos	Specification-Bestimmung-Omschrijving	Pcs	Profile (mm)	L (mm)
SS1	STORM SLAT-STURMLEISTE-STORMLIJST 	7	18x35	2160
WCM	WALLBEAMS CONNECTING METAL-WANDBOEHLEN BEFESTIGUNG METALLE-MUURBALKEN POOLING METALEN 	19	20	20
PRN	POST REGULATOR-PFOSTEN REGLER-STUT REGELAAR 	2		
	SCREWS-SCHRAUBEN-SCHROEF FOR-FÜR-VOOR SS1 	21	∅6.0	50
	WASHER-SCHEIBE-SCHIJF FOR-FÜR-VOOR SS1 	21	∅6.0	18
	NAIL-NAGEL-NAGEL FOR-FÜR-VOOR R1, R2 	500	∅2.5	60
	SCREWS-SCHRAUBEN-SCHROEF FOR-FÜR-VOOR WCM 	76	∅3.5	35
	SCREWS-SCHRAUBEN-SCHROEF FOR-FÜR-VOOR PRN 	16	∅6.0	45
	SCREWS-SCHRAUBEN-SCHROEF FOR-FÜR-VOOR GB1, GB2, EL 	50	∅4.5	50
	SCREWS-SCHRAUBEN-SCHROEF FOR-FÜR-VOOR FR1 	40	∅4.5	70
	SCREWS-SCHRAUBEN-SCHROEF FOR-FÜR-VOOR FS1, 025, 027, 028 	30	∅4.5	90
	SCREWS-SCHRAUBEN-SCHROEF FOR-FÜR-VOOR FR2-1, FR2-2, FR3-1, FR3-2 	40	∅5.0	120
	SCREWS-SCHRAUBEN-SCHROEF 001, 002, 011, 021 FOR-FÜR-VOOR FR2-1, FR2-2, FR3-1, FR3-2, FR4, FR5, FR6 	60	∅6.0	160
	DOUBLEDOOR-DOPPELTÜR-DUBBELE DEUR (right-rechts-rechts) AST_PL  	P 1	1500	1850
	DOOR-TÜR-DEUR (right-rechts-rechts) AST_PL  	P 1	900	1850

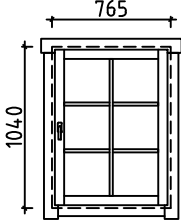
Pos	Specification-Bestimmung-Omschrijving	Pcs	Profile (mm)	L (mm)
	<p data-bbox="264 145 922 219">WINDOW-FENSTER-VENSTER (1x right-rechts-rechts; 1x left-links-links) AST</p> 	<p data-bbox="1222 145 1273 174">P+V</p> <p data-bbox="1289 145 1324 174">1+1</p> <p data-bbox="1289 230 1308 259">2</p> <p data-bbox="1289 315 1308 344">2</p>	<p data-bbox="1374 145 1425 174">765</p>	<p data-bbox="1481 145 1532 174">1040</p>
House 2827980	Material	File 2827980.dwg	Sheet 15	

#001	1,2	4586	2
#002	1,2	4586	2
#003	2	4401	7
#004		4400	1
#005	2	4286	8
#006	1	3298	1
#007	B,C	3200	2
#008	A,D	3200	2
#009	B,C,D	3200	32
#010	C,D	3200	2
#011	B	3200	1
#012	A	3200	1
#013	B,C	2629	2
#014	B	2098	1
#015	B	2028	1
#016	B	2028	5
#017	B	2028	1
#018	1	1909	6
#019	B,C	1887	2
#020	2	1729	8
#021	1,2	1614	2
#022	1,2	1614	9
#023	1	724	8
#024	B	693	7
#025	A,D	680	4
#026	B	560	7
#027	A,D	555	2
#028	A,D	553	4
#029	B,C	518	4
#030	1	410	8
#031	1	409	14
#032	B,C	147	4