

Model	4415320	Seite/Page	1
Zeichnung/Drawing	3D	Maßstab/Scale	
Profil/Profile	44x135	Datum/Date	26.04.2025
Zeichner/Drafter	SRM	File	4415320.dwg

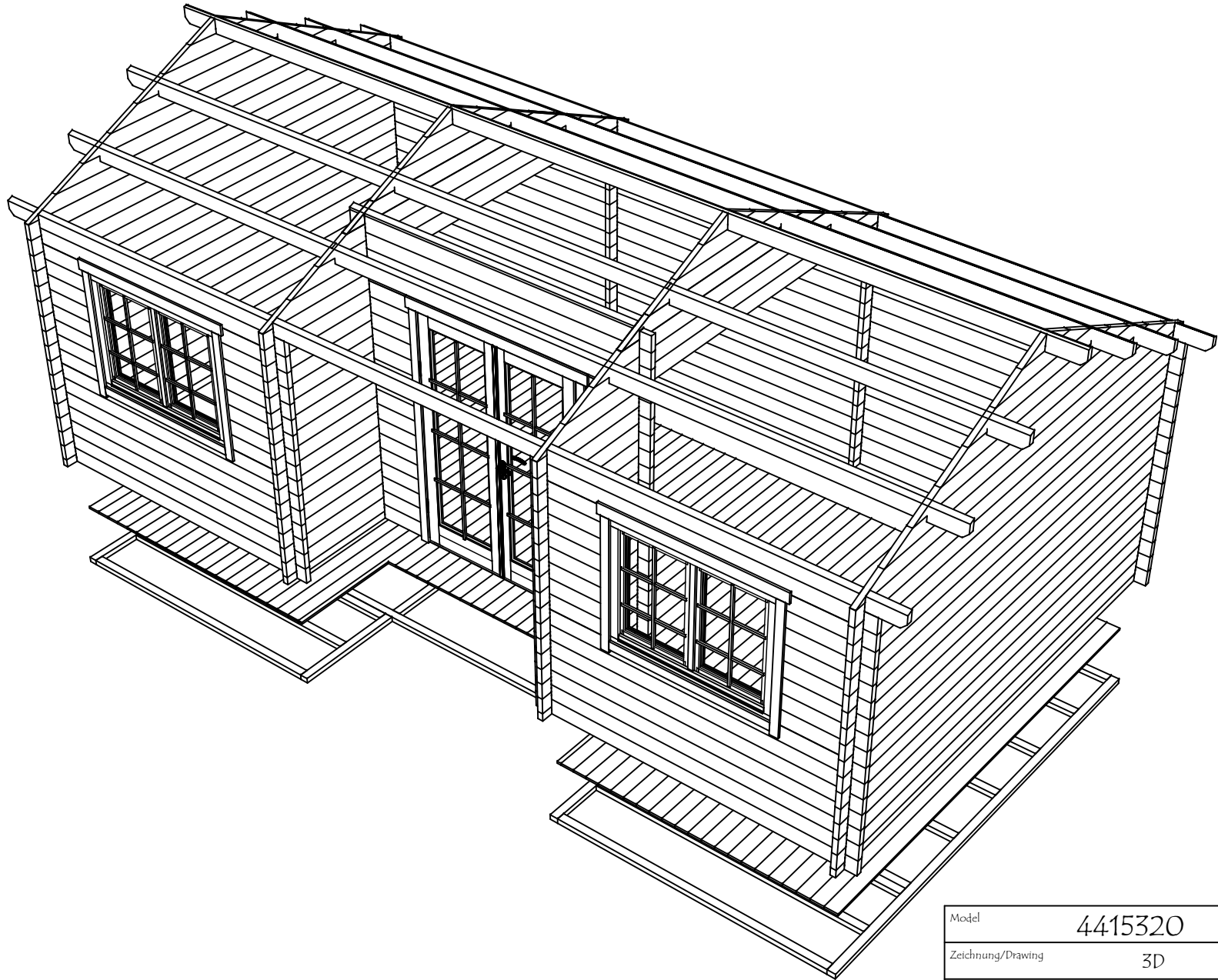

Model	4415320	Seite/Page	2
Zeichnung/Drawing	3D	Maßstab/Scale	
Profil/Profile	44x135	Datum/Date	26.04.2025
Zeichner/Drafter	SRM	File	4415320.dwg

H = 1.700 m  
 TOTAL: 28.40 m<sup>2</sup>

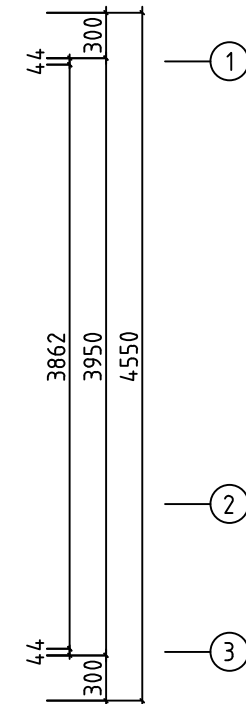
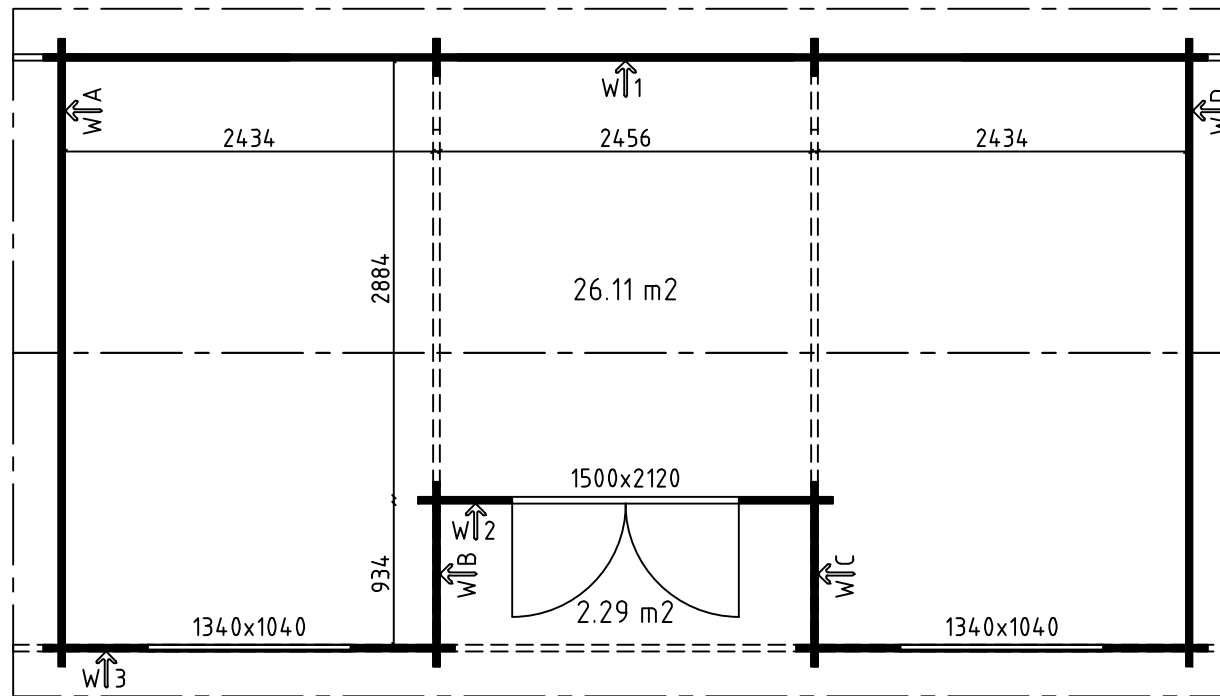
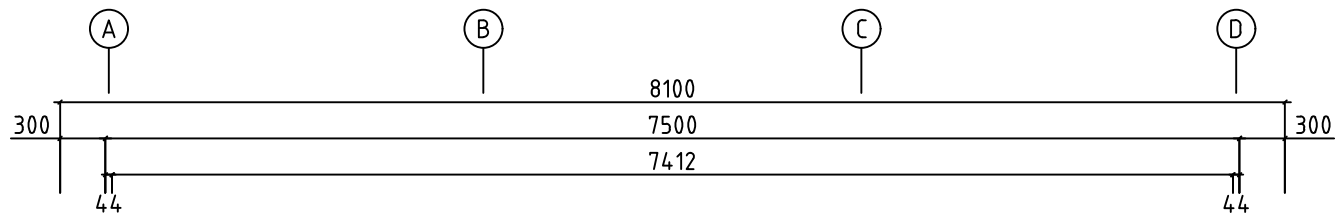

Model	4415320	Seite/Page	3
Zeichnung/Drawing	GRUNDPLAN - GRUNDPLAN	Maßstab/Scale	1:50
Profil/Profile	44x135	Datum/Date	26.04.2025
Zeichner/Drafter	SRM	File	4415320.dwg

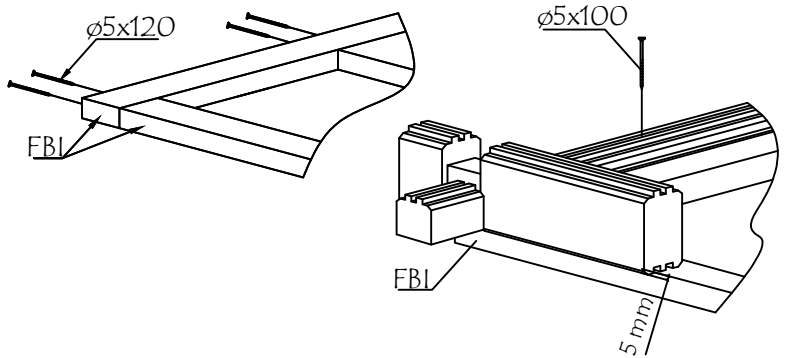
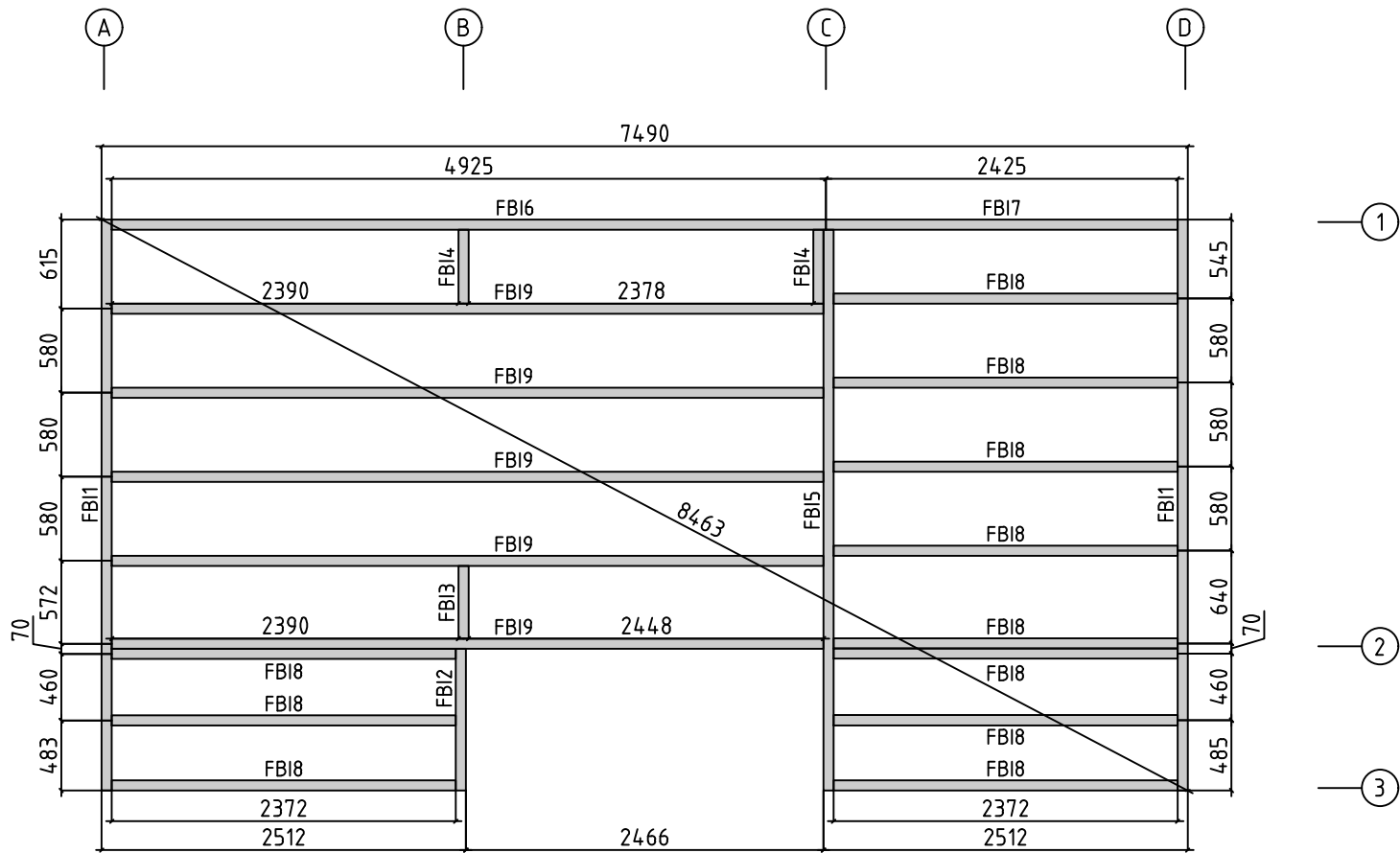

Model	4415320	Seite/Page	4
Zeichnung/Drawing	FUNDAMENTHOLZ (IMM) - FOUNDATION BEAM (IMM)	Maßstab/Scale	1:50
Profil/Profile	70x45	Datum/Date	26.04.2025
Zeichner/Drafter	SRM	File	4415320.dwg

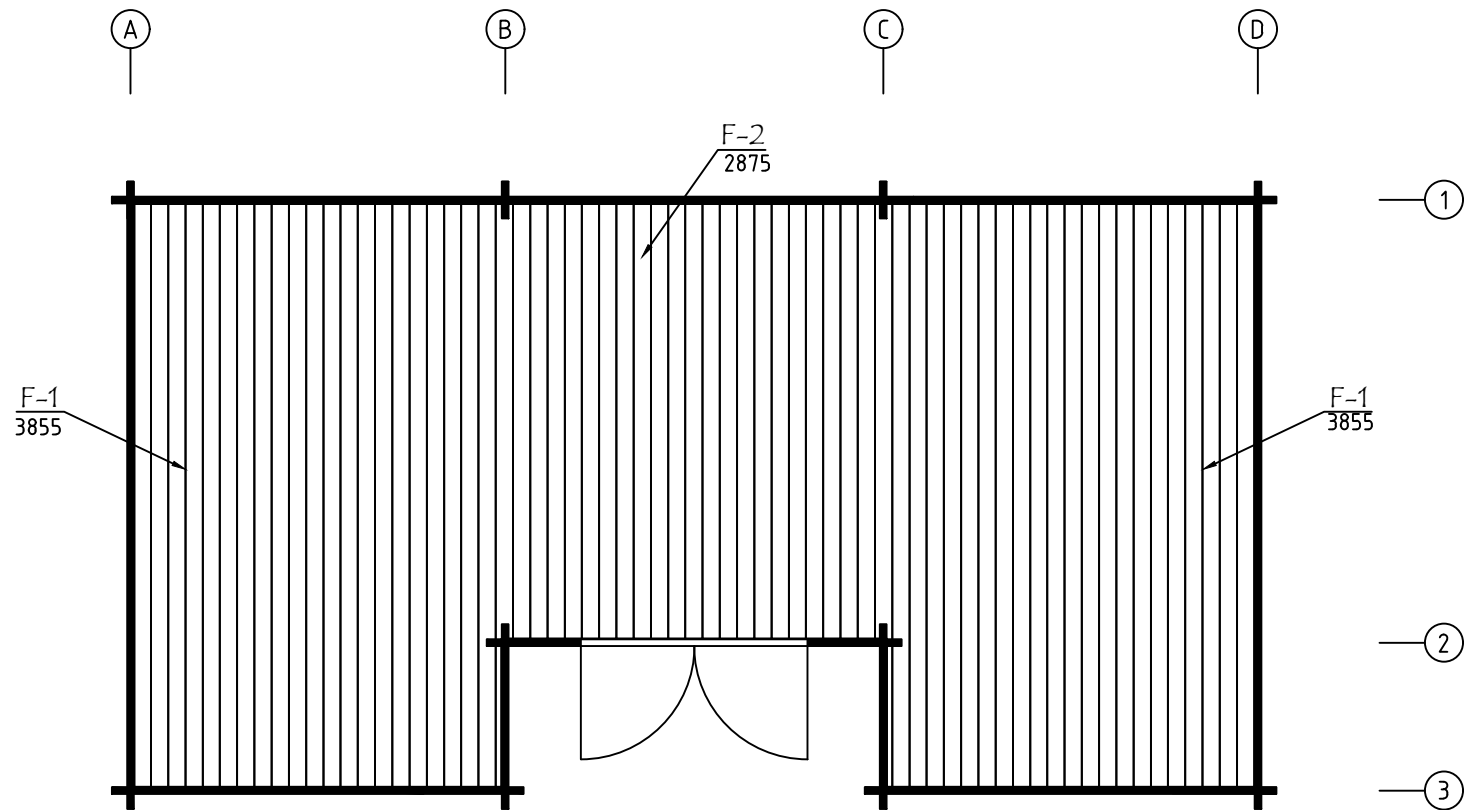

Model	4415320	Seite/Page	5
Zeichnung/Drawing	FUSSBODENBRETTER-FLOOR BOARDS	Maßstab/Scale	1:50
Profil/Profile	114x18 oder-or 88x18	Datum/Date	26.04.2025
Zeichner/Drafter	SRM	File	4415320.dwg

A

B

C

D

R-1  
2500

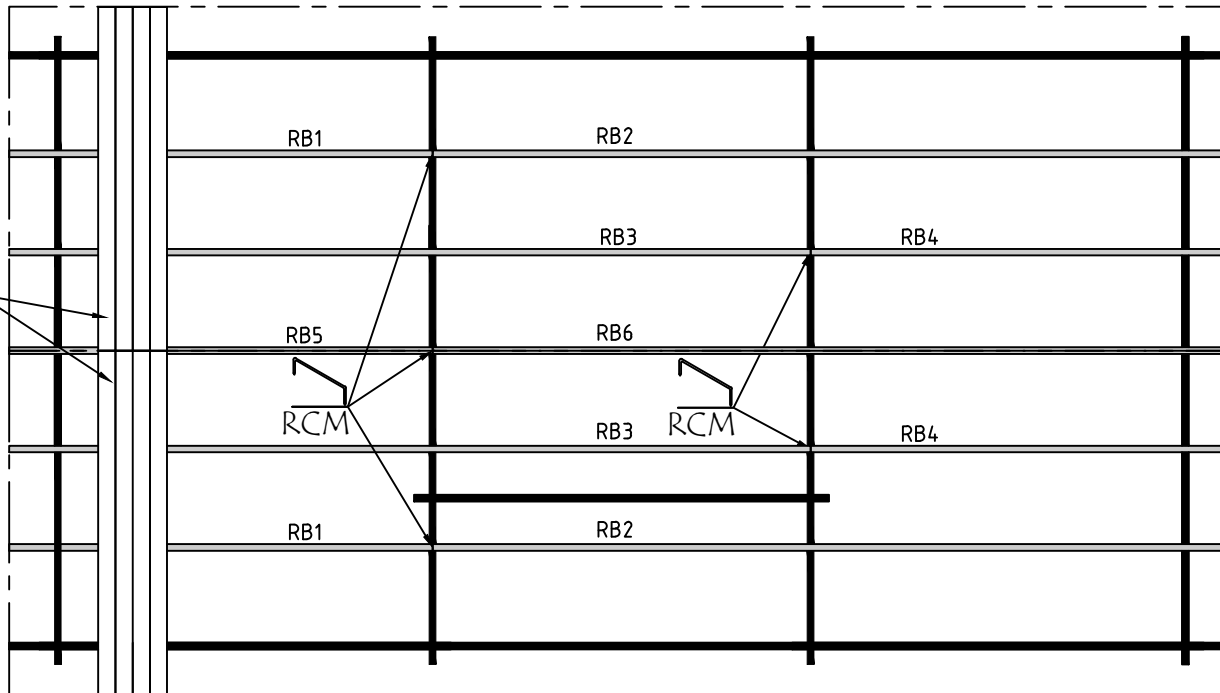

1

2

3

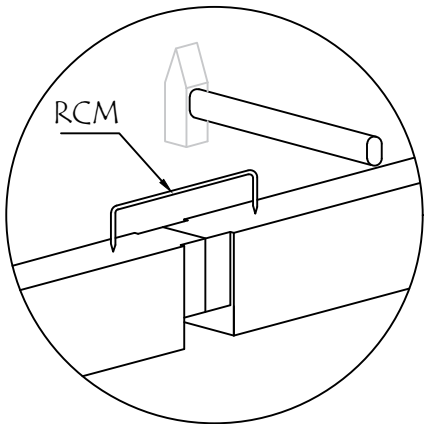

Model	4415320	Seite/Page	6
Zeichnung/Drawing	DACHBRETTER - ROOF BOARDS	Maßstab/Scale	1:50
Profil/Profile	88x18 oder- or 114x18 / 43x140	Datum/Date	26.04.2025
Zeichner/Drafter	SRM	File	4415320.dwg

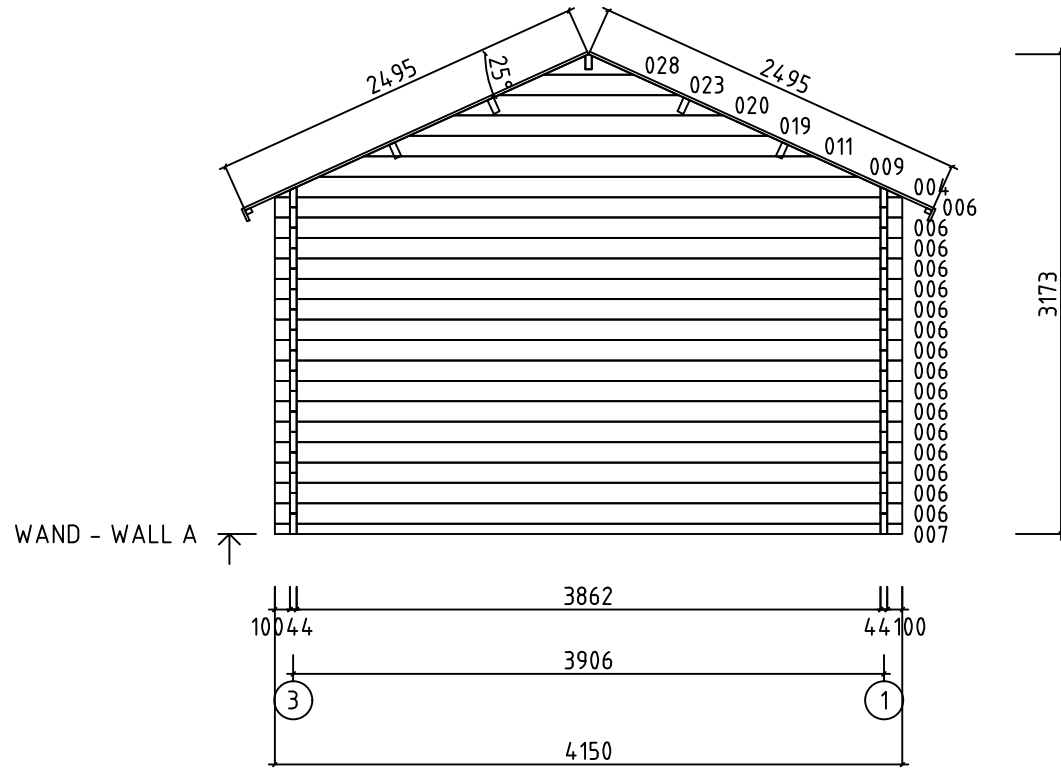
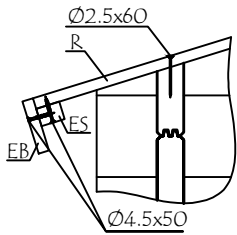

Model	4415320	Seite/Page	7
Zeichnung/Drawing	WAND - WALL A	Maßstab/Scale	1:50
Profil/Profile	44x135	Datum/Date	26.04.2025
Zeichner/Drafter	SRM	File	4415320.dwg

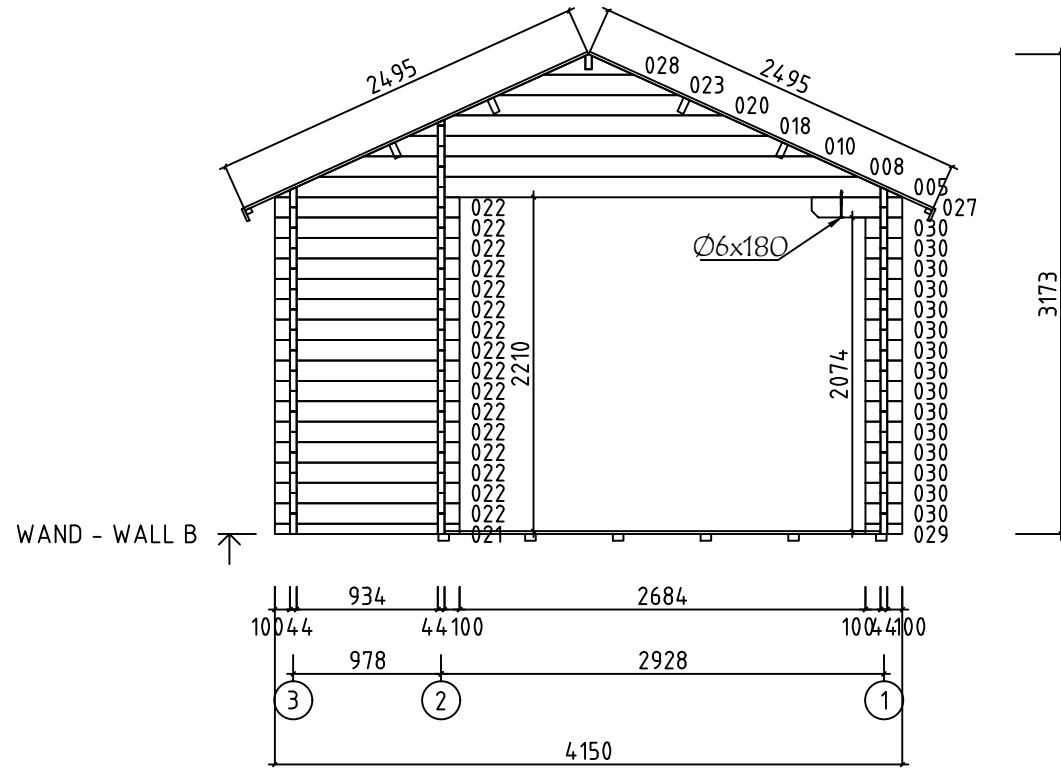
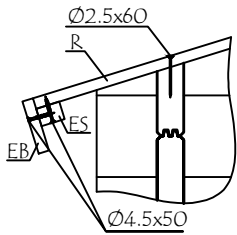

Model	4415320	Seite/Page	8
Zeichnung/Drawing	WAND - WALL B	Maßstab/Scale	1:50
Profil/Profile	44x135	Datum/Date	26.04.2025
Zeichner/Drafter	SRM	File	4415320.dwg

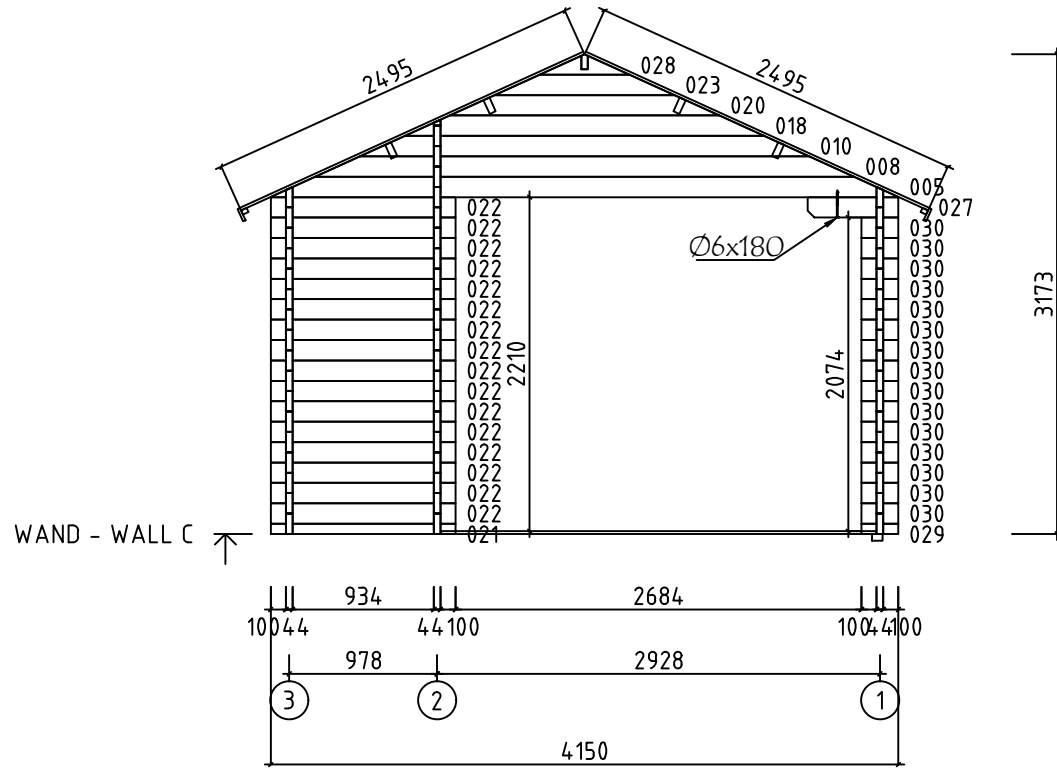
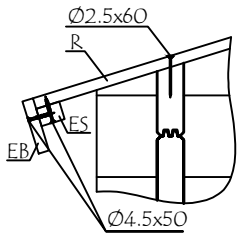

Model	4415320	Seite/Page	9
Zeichnung/Drawing	WAND - WALL C	Maßstab/Scale	1:50
Profil/Profile	44x135	Datum/Date	26.04.2025
Zeichner/Drafter	SRM	File	4415320.dwg

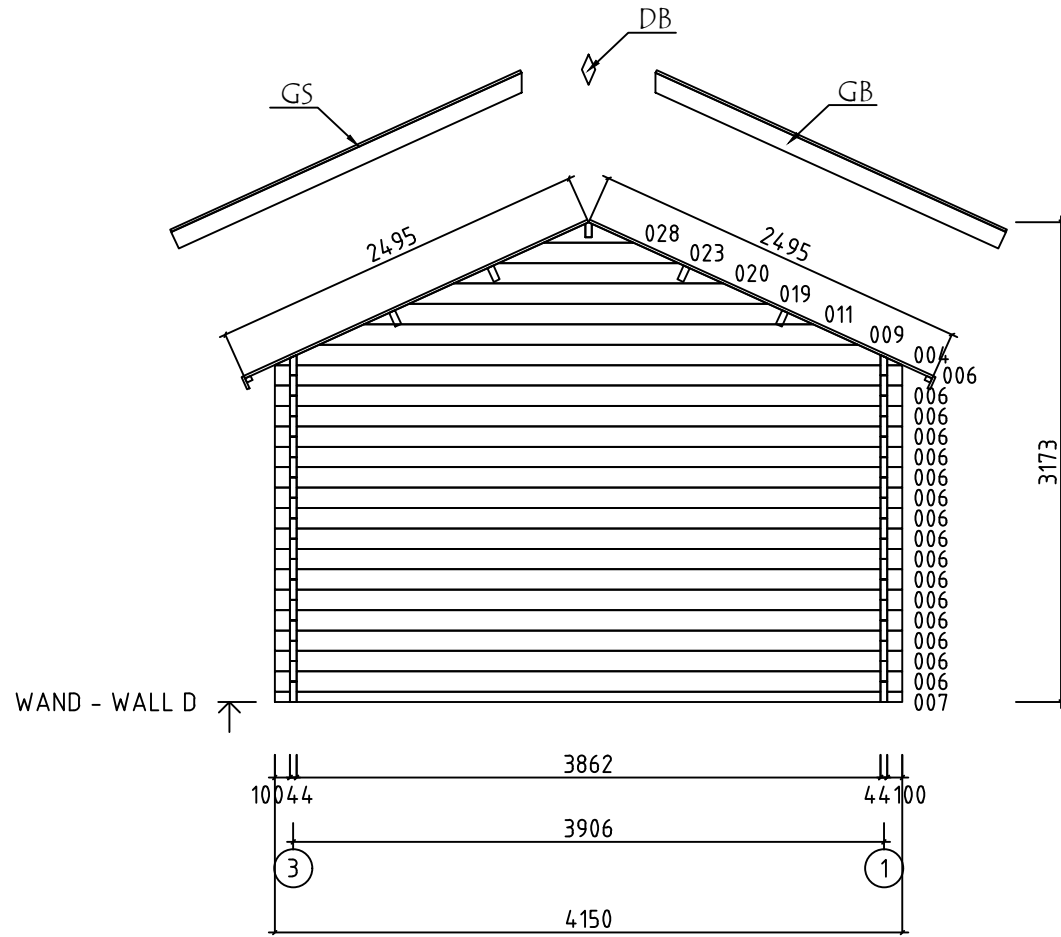
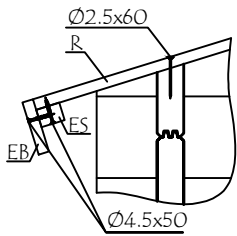

Model	4415320	Seite/Page	10
Zeichnung/Drawing	WAND - WALL D	Maßstab/Scale	1:50
Profil/Profile	44x135	Datum/Date	26.04.2025
Zeichner/Drafter	SRM	File	4415320.dwg

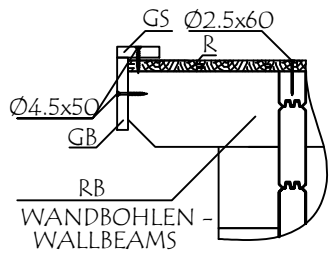

WAND - WALL 1 ↑

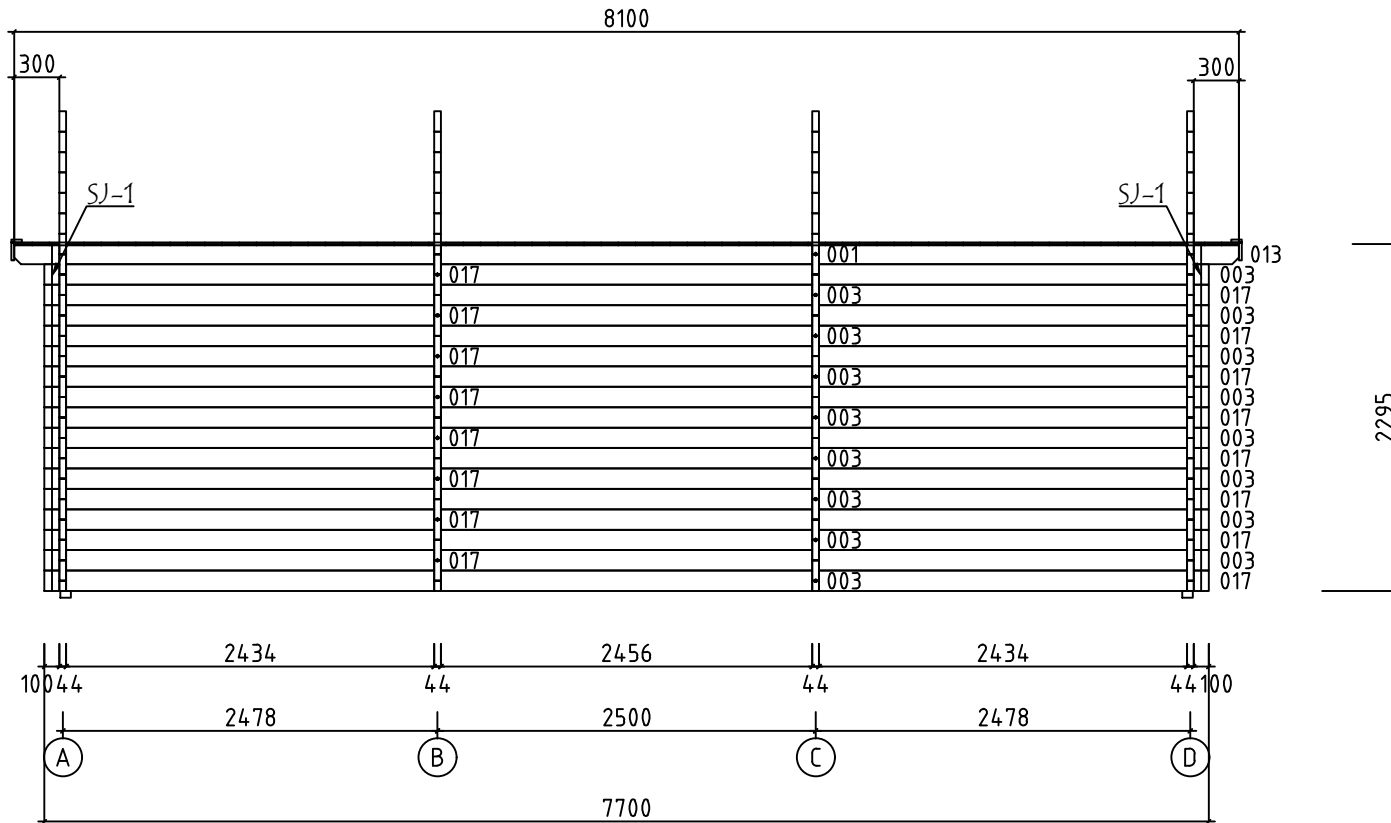

Model	4415320	Seite/Page	11
Zeichnung/Drawing	WAND - WALL 1	Maßstab/Scale	1:50
Profil/Profile	44x135	Datum/Date	26.04.2025
Zeichner/Drafter	SRM	File	4415320.dwg

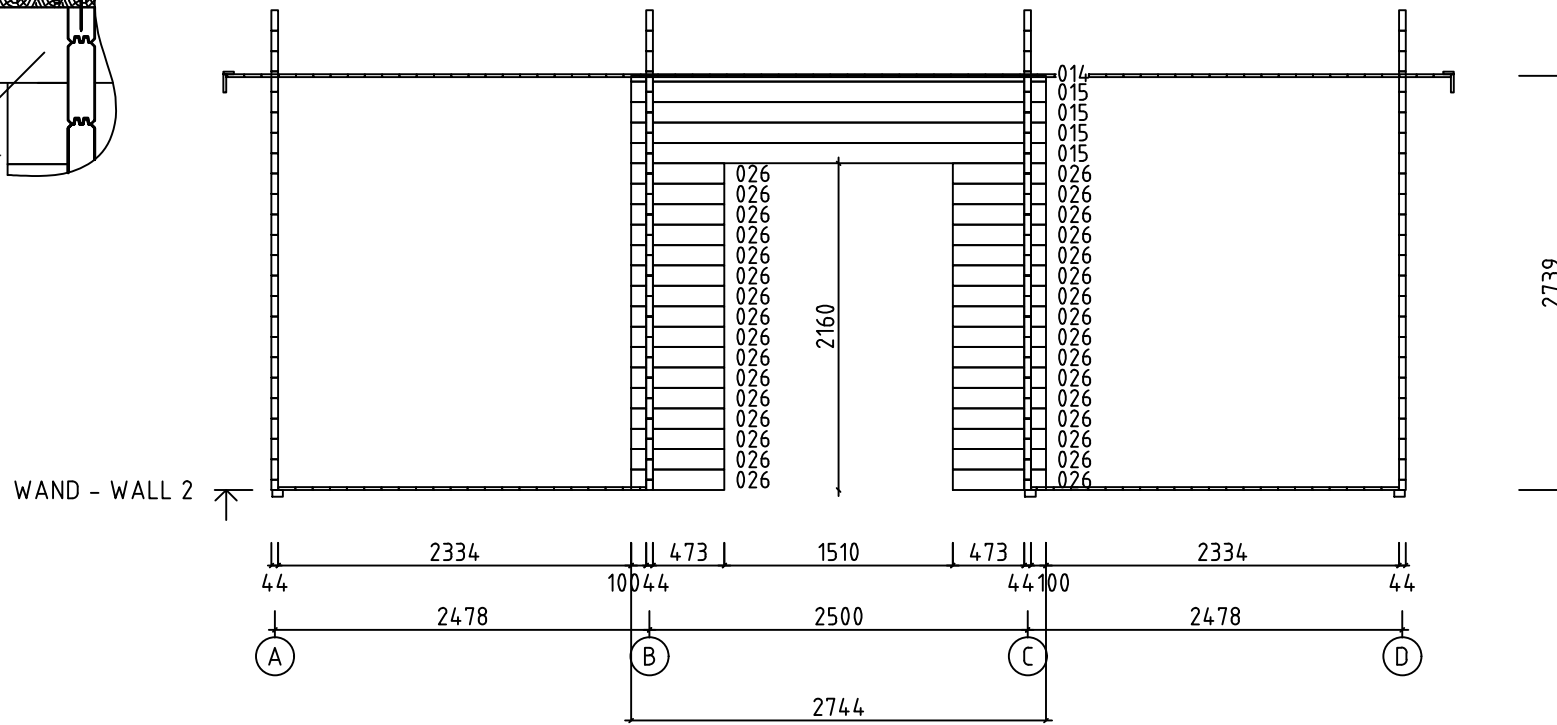
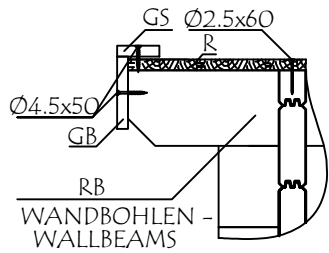

Model	4415320	Seite/Page	12
Zeichnung/Drawing	WAND - WALL 2	Maßstab/Scale	1:50
Profil/Profile	44x135	Datum/Date	26.04.2025
Zeichner/Drafter	SRM	File	4415320.dwg

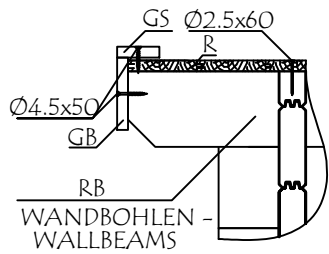



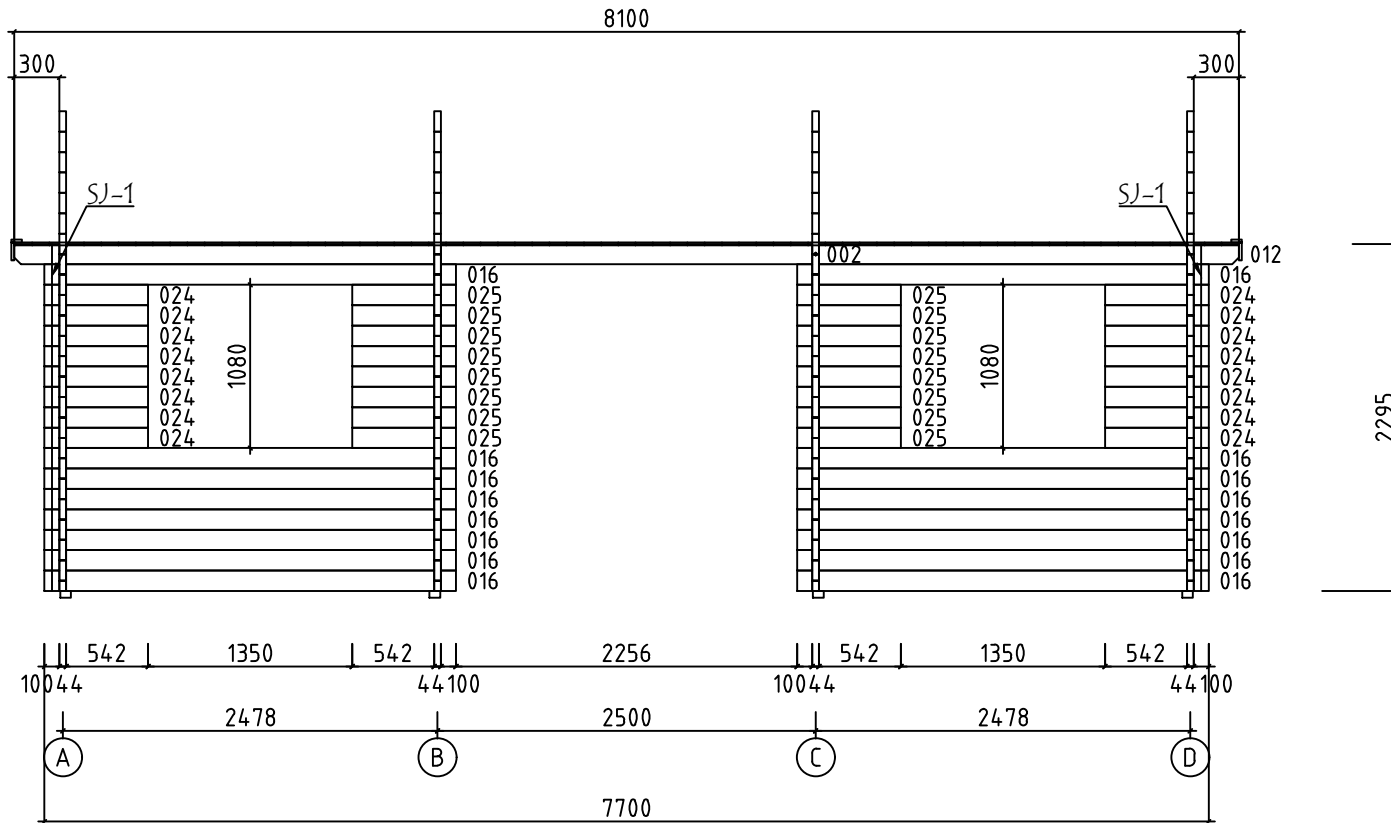







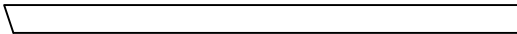
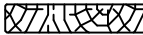









WAND - WALL 3 ↑



Model	4415320	Seite/Page	13
Zeichnung/Drawing	WAND - WALL 3	Maßstab/Scale	1:50
Profil/Profile	44x135	Datum/Date	26.04.2025
Zeichner/Drafter	SRM	File	4415320.dwg

Pos	Bestimmung-Specification 4415320	Stck. Pcs.	Profil Profile (mm)	Länge Length (mm)	
1	100 4956 ERZATZBOHLE-SPARE BEAM 	1	44x135	5100	
001	300 2434 2456 	1	44x135	5300	
002	300 2434 2456 	1	44x135	5300	
003	100 2434 2456 	16	44x135	5100	
006	100 3862 100 	32	44x135	4150	
007	100 3862 100 	2	44x68	4150	
012	2434 300 	1	44x135	2800	
013	2434 300 	1	44x135	2800	
014	100 2456 100 	1	44x39	2744	
015	100 2456 100 	4	44x135	2744	
016	100 2434 100 	16	44x135	2722	
017	2434 100 	16	44x135	2600	
021	100 934 100 	2	44x68	1222	
022	100 934 100 	32	44x135	1222	
024	100 542 	16	44x135	686	
025	542 100 	16	44x135	686	
026	473 100 	32	44x135	617	
027	456 100 	2	44x135	600	
029	100 100 	2	44x68	244	
030	100 100 	30	44x135	244	
WA-1 WD-1		1 1	44x935	4150	
Model	4415320	Datum/Date	26.04.2025	Seite/Page	1/4

Pos	Bestimmung-Specification 4415320		Stck. Pcs.	Profil Profile (mm)	Länge Length (mm)	
WB-1 WC-1			1 1	44x935	4150	
SH	SCHLAGHOLZ - HAMMER BLOCK 44 MM		2	44x135	300	
FBI1	FUNDAMENTHOLZ (IMM) - FOUNDATION BEAM (IMM) 		2	70x45	3940	
FBI2	FUNDAMENTHOLZ (IMM) - FOUNDATION BEAM (IMM) 		1	70x45	978	
FBI3	FUNDAMENTHOLZ (IMM) - FOUNDATION BEAM (IMM) 		1	70x45	502	
FBI4	FUNDAMENTHOLZ (IMM) - FOUNDATION BEAM (IMM) 		2	70x45	510	
FBI5	FUNDAMENTHOLZ (IMM) - FOUNDATION BEAM (IMM) 		1	70x45	3870	
FBI6	FUNDAMENTHOLZ (IMM) - FOUNDATION BEAM (IMM) 		1	70x45	4925	
FBI7	FUNDAMENTHOLZ (IMM) - FOUNDATION BEAM (IMM) 		1	70x45	2425	
FBI8	FUNDAMENTHOLZ (IMM) - FOUNDATION BEAM (IMM) 		11	70x45	2372	
FBI9	FUNDAMENTHOLZ (IMM) - FOUNDATION BEAM (IMM) 		5	70x45	4908	
RB1	DACHBALKEN - ROOF BEAM 		2	43x140	2800	
RB2	DACHBALKEN - ROOF BEAM 		2	43x140	5300	
RB3	DACHBALKEN - ROOF BEAM 		2	43x140	5300	
RB4	DACHBALKEN - ROOF BEAM 		2	43x140	2800	
RB5	DACHBALKEN - ROOF BEAM 		1	43x140	2800	
RB6	DACHBALKEN - ROOF BEAM 		1	43x140	5300	
R-1	DACHBRETT - ROOFBOARD	88mm or-oder 114mm		184+2 144+2	88x18 114x18	2500
F-1	FUSSBODENBRETT - FLOOR BOARDS	88mm or-oder 114mm		56+1 44+1	88x18 114x18	3855
F-2	FUSSBODENBRETT - FLOOR BOARDS	88mm or-oder 114mm		29 21	88x18 114x18	2875
FF-1	FUSSBODENLEISTEN FLOOR STRIPS				18x35	27,0 lfm/rm
Model	4415320	Datum/Date	26.04.2025	Seite/Page	2/4	

Pos	Bestimmung-Specification 4415320	Stck. Pcs.	Profil Profile (mm)	Länge Length (mm)
GB1-1	GIEBELLEISTE - GABLE MOULDING 	4	18x120	2550
EB2-1	TRAUFENBRETTER - EAVES BOARD 	4	18x90	4050
ES-1	TRAUFENLEISTE - EAVES STRIPS 	4	30x40	4050
GS-1	GIEBELDECKLEISTE - GABLE COVER STRIPS 	4	18x70	2550
DB	GIEBELSEGMENT - GABLE DIAMOND 	2	18x90	200
RCM	DACHBALKEN BEFESTIGUNGSMETALLE M6 200MM - ROOFBEAMS CONNECTING METAL M6 200MM 	5		
SJ-1	GEWINDESTANGE M10 - TREADED ROD M10 	4		2330
HS	SCHRAUBEN FÜR GIEBELSEGMENT - SCREWS FOR GABLE DIAMOND / DB 	4	Ø3.5x35	
HS1	SCHRAUBEN FÜR WANDBOHLNEN BEFESTIGUNG METALLESCREW - SCREWS FOR WALLBEAMS CONNECTING METAL WBM 	72	Ø3.5x35	
HS	SCHRAUBEN FÜR GIEBELLEISTE - SCREWS FOR GABLE MOULDING / GB 	32	Ø4.5x50	
HS	SCHRAUBEN FÜR TRAUFENBRETTER - SCREWS FOR EAVES BOARD / EB 	32	Ø4.5x50	
HS	SCHRAUBEN FÜR TRAUFENLEISTE - SCREWS FOR EAVES STRIPS / ES 	32	Ø4.5x50	
HS	SCHRAUBEN FÜR GIEBELDECKLEISTEN - SCREWS FOR GABLE COVER STRIPS / GS 	20	Ø4.5x50	
HS	SCHRAUBEN FÜR 1. BOHLENREIHE - SCREWS FOR 1. WALL BEAM 	36	Ø5.0x100	
HS	SCHRAUBEN FÜR FUNDAMENTHOLZ - SCREWS FOR FOUNDATION BEAM / FBI 	84	Ø5.0x120	
HS	SCHRAUBEN FÜR DACHBALKEN - SCREWS FOR ROOF BEAM / RB 	25	Ø6x160	
HS	SCHRAUBEN FÜR Pos. - SCREWS FOR Pos. 027 	2	Ø6x160	
NF	NÄGEL FÜR DACHBRETTER - NAILS FOR ROOF BOARDS / R 	1152	Ø2.5x60	
NF	NÄGEL FÜR FUSSBODENBRETTER - NAILS FOR FLOOR BOARDS / F 	956	Ø2.5x60	
NF	NÄGEL FÜR FUSSBODENLEISTE - NAILS FOR FLOOR STRIPS / FF 	90	Ø2x40	
WBM2	WANDBOHLNEN BEFESTIGUNG METALLE - WALLBEAMS CONNECTING METAL 	18	25x25	
Model	4415320	Datum/Date	26.04.2025	Seite/Page 3/4

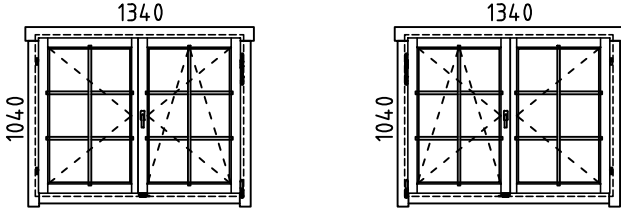
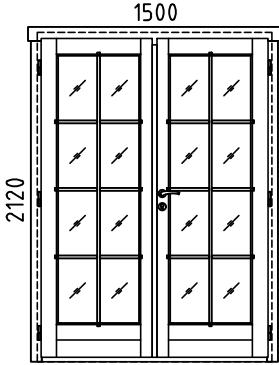
Pos	Bestimmung-Specification 4415320	Stck. Pcs.	Profil Profile (mm)	Länge Length (mm)
AST PRE	FENSTER - WINDOW  DIN RECHTS/RIGHT HANDED DIN LINKS/LEFT HANDED  	1  1	1340x1040  1340x1040	
AST PRE	TÜR - DOOR  DIN RECHTS/RIGHT HANDED  	1	1500x2120	
✘	BITTE SELBER ANPASSEN (FALLS NÖTIG)! - CUT INTO LENGTH ON SITE (IF NEEDED)!			
Model	4415320	Datum/Date	26.04.2025	Seite/Page 4/4