

Petro 598x448 VD 28

3D

2.8x11.4

27.06.2025

H = 1.700 m
TOTAL: 19.61 m²

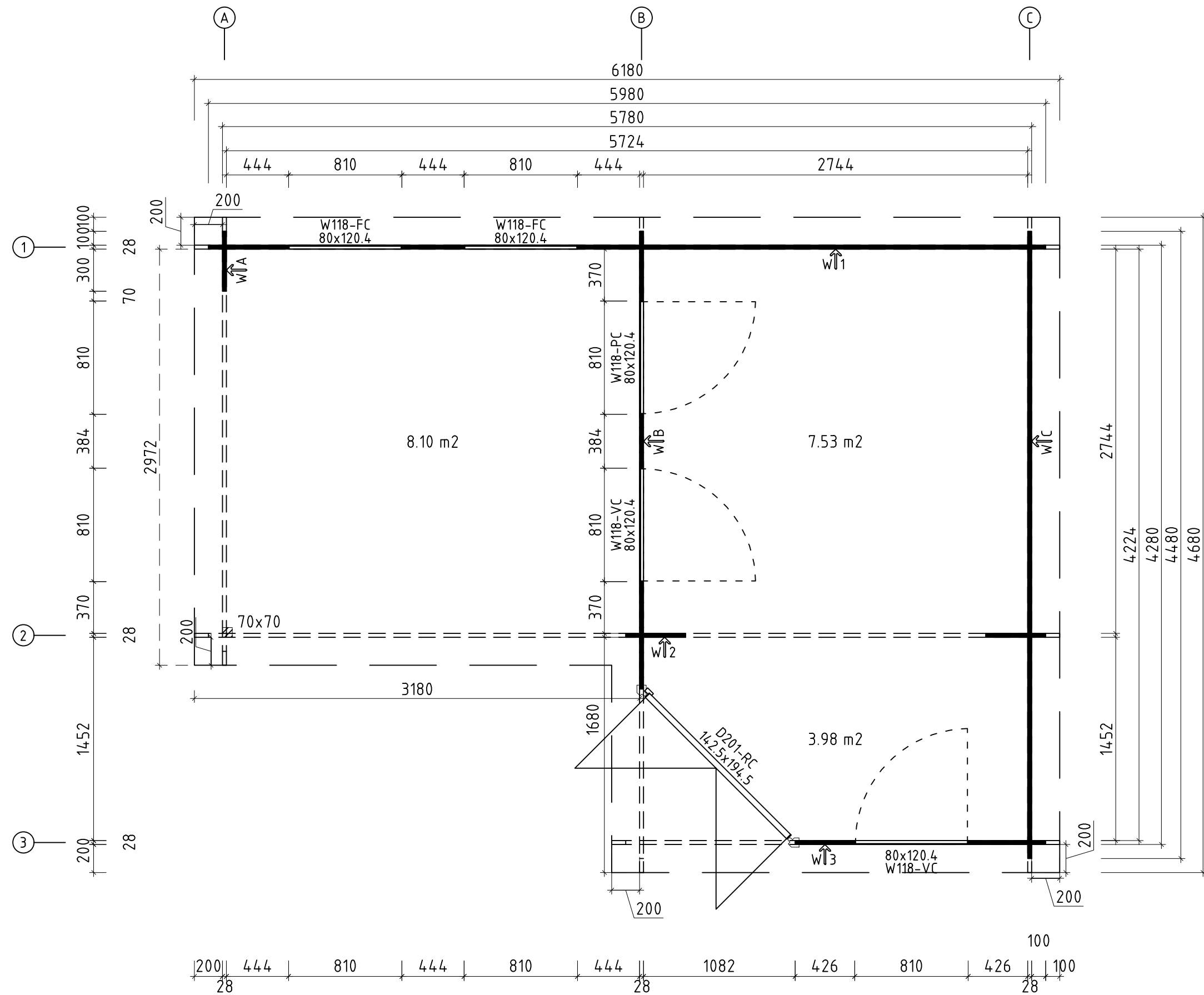

Q2 – Qualitätsklasse für Fenster und Türen
* Fenster und Türen sind mit Sprossen

Petro 598x448 VD 28		
Grundplan		
2.8x11.4	27.06.2025	

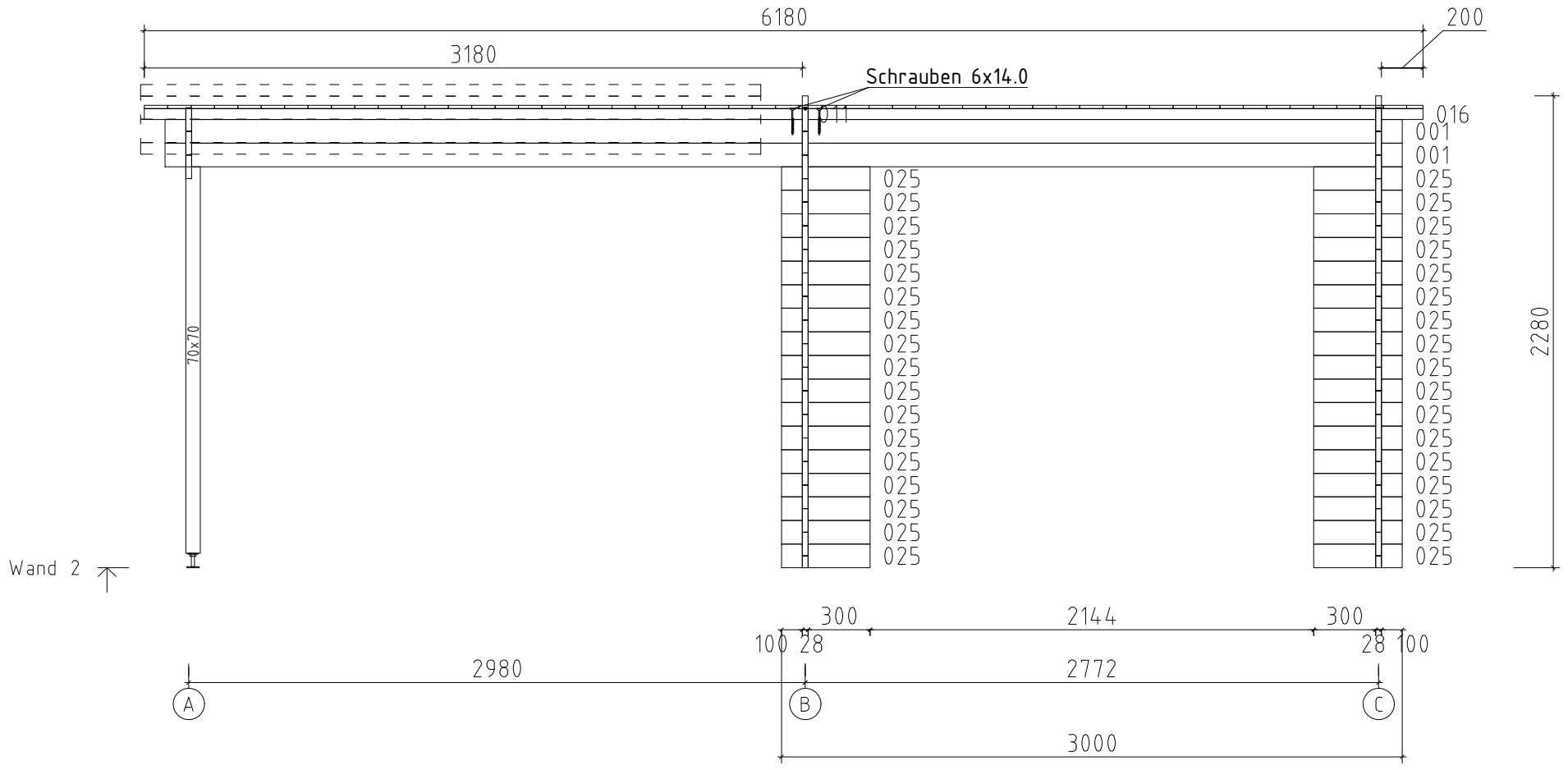

Wand 2 ↗

Schrauben 6x14.0

A

B

C



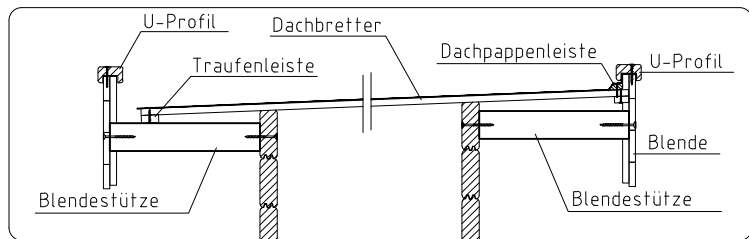
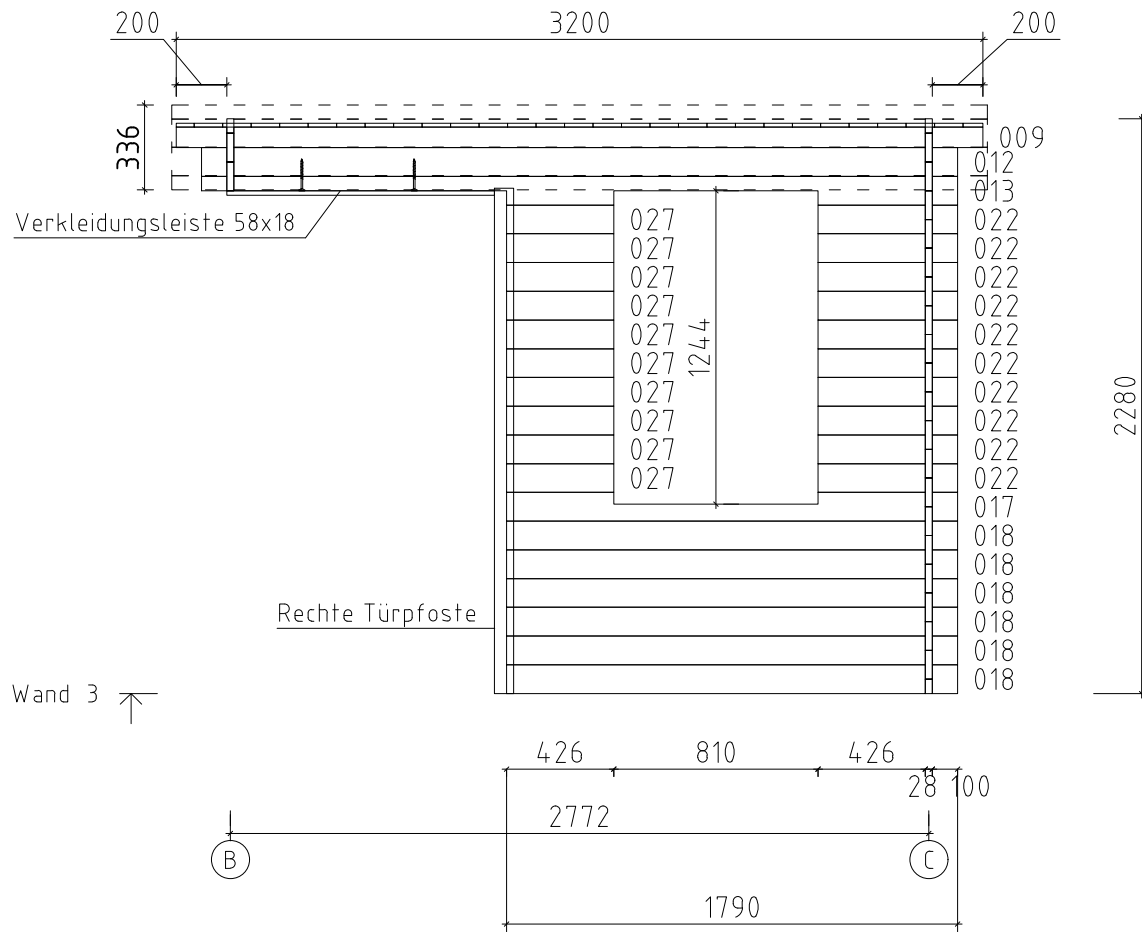



Petro 598x448 VD 28		
WAND 2		
	2.8x11.4	27.06.2025

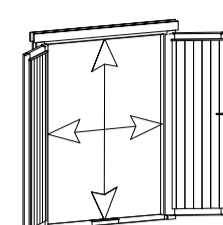
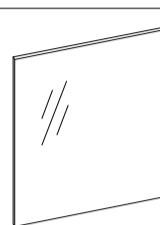

Petro 598x448 VD 28		
WAND 3		
	2.8x11.4	27.06.2025

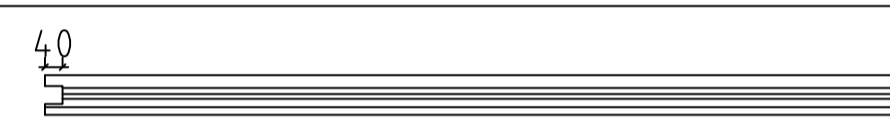
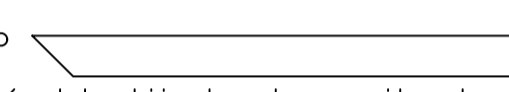
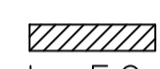
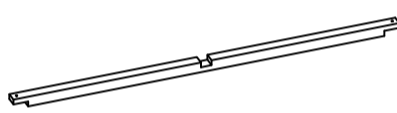
Pos	Teieliste Petro 598x448 VD 28	Stck	Profil (mm)	Länge (mm)
001		9	28x114	5980
003		17	28x114	4480
004		1	28x57	4480
005		11	28x114	3344
006		6	28x114	3270
007		1	28x57	3270
009		1	28x82	3200
010		1	28x114	3194
011		1	28x53	3194
012		1	28x114	3000
013		1	28x114	3000
014		1	28x114	3000
015		1	28x114	2986
016		1	28x53	2986
017		1	28x114	1790
018		6	28x114	1790
020		11	28x114	768
021		11	28x114	572
022		10	28x114	554
023		11	28x114	498
024		11	28x114	444
025		50	28x114	428
026		1	28x57	428
027		10	28x114	426
028		11	28x114	384
Kood	Petro 598x448 VD 28	Materjal		Leht 1/8

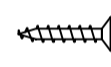
Pos	Teilleiste Petro 598x448 VD 28		Stck	Profil (mm)	Länge (mm)
WA-1			1		
WB-1			1		
WC-1			1		
BS1	BLENDENSTÜTZE 		10	44x65	200
PF1	PFETTEN 		3	44x145	3294
PF3	PFETTEN 		1	44x145	3200
PF2	PFETTEN 		3	44x145	3086
	DACHBRETTER		29+1	113x16	4581
	DACHBRETTER		26	113x16	3101
BL-1	DACHBLENDEN 336mm		1	18x336	1480
BL-2	DACHBLENDEN 336mm		1	18x336	2980
BL-3	DACHBLENDEN 336mm		2	18x336	3108
BL-4	DACHBLENDEN 336mm		1	18x336	3200
BL-5	DACHBLENDEN 336mm		1	18x336	3236
BL-6	DACHBLENDEN 336mm		1	18x336	4680
UPB-1	DACHBLENDEN- U-Profil für Blenden			65x44	23.0lfm
DPL-1	DACHPAPPENLEISTEN 15x28			15x28	16.0lfm
T06-1	TRAUFENLEISTEN 18x40			18x40	13.0lfm
VL-1	DACHBLENDEN- Verbindungsleisten		1	18x120	336
SM-1	Sturmleisten		2	18x40	1995
SM-2	Sturmleisten		2	18x40	2109
TP70-1	STÜTZPFOSTEN 70x70		1	70x70	1868
Kood	Petro 598x448 VD 28		Materjal		Leht 2/8

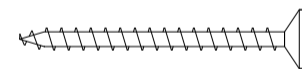
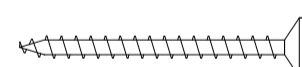
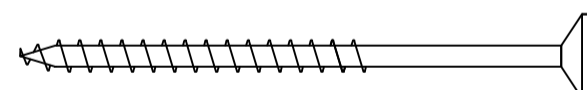
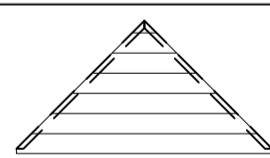
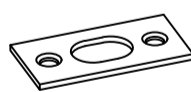
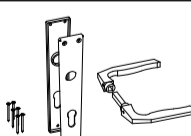
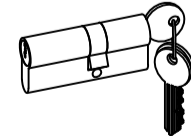
Pos	Teieliste Petro 598x448 VD 28	Stck	Profil (mm)	Länge (mm)	
	<p>TÜR 1425x1945 D2-M28R-56C-14251945</p> <p>Q2 D201-RC 1425</p>  <p>Right handed / DIN rechts / paremakäeline</p> <p>Clear opening/ durchgangsmaß/ ava suurus 1337x1857mm</p>  <p>Clear float glass klares Floatglas kirgas klaas</p> 	1			
DzT40-01-1	CD- cover strip for door - ET- Deckbrett zum Tür - NU- Katteliist ukse kohale 40		1	18x40	1585
P7L-01-1	CD- left hand doorpost - ET- linke Türpfoste - NU- vasak uksepost 28		1	67x77	2005
P7R-01-1	CD- right hand doorpost - ET- rechte Türpfoste - NU- parem uksepost 28		1	67x77	2005
VK1-01-1	CD- trim strips for canopy element - ET- Verkleidungsleisten für Vordachelement - NU- Katteliistud varikatusele 58	  ✓	2	58x18	1110
PROSS H1-2	Q2-Q3-1 Muntins - Sprossen - Prossid horizontal 18x18		4	18x18	517
PROSS V2-2	Q2-Q3-2 Muntins - Sprossen - Prossid vertical 18x18		2	18x18	975
SR25 15-01	2.5x15 Locking plate - Schließblech - Riivi vastus 01 Q2-Q3		2		
SR30 22-01	3.0x20ÜP Muntins - Sprossen - Prossid		12		
SR35 45-05	3.5x45 Canopy element - Vordachelement - Varikatus		6		
SR35 45-03	3.5x45 Cover strip - Deckbrett - Katteliist ukse kohale		3		
SR35 45-04	3.5x45 Trim strips - Verkleidungsleiste - Katteliist varikatusele		6		
SR50 90-01	5.0x90 Door frames - Türrahmen - Ukselengid		8		
VE1-01	CD- canopy element - ET- Vordachelement - NU- Varikatus uksele 1435x745		1		
RV01	Locking plate - Schließblech - Riivi vastus 01 Q2-Q3		1		
UL-Q 2-Q3	Q2-Q3 Door handle - Türgriff - Ukselink		1		
LS-Q4	Q4 Cylinder lock - Zylinderschloss - Lukusüdamik		1		
Kood	Petro 598x448 VD 28	Materjal	Leht	8/8	

Step 1: Dachelement an den Wänden verschrauben.
Step 1: Screw canopy element to the wall.

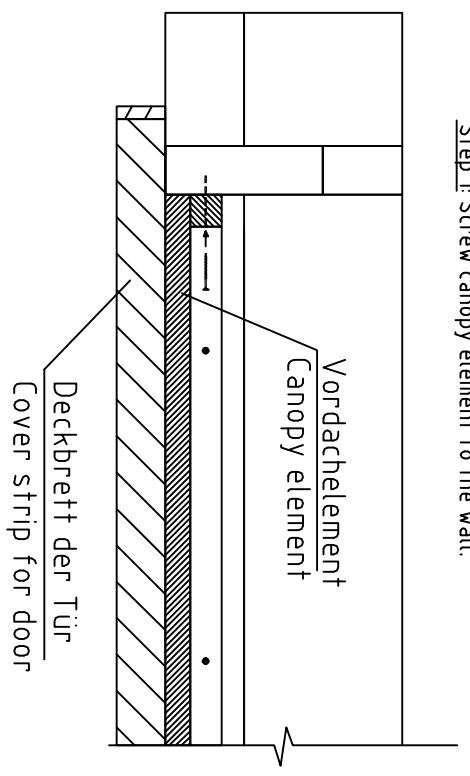

Step 2: Das Deckbrett muss von oben (durch das VD-Element) an das Dachelement verschraubt werden.
Step 2: Fasten cover strip to the canopy element.

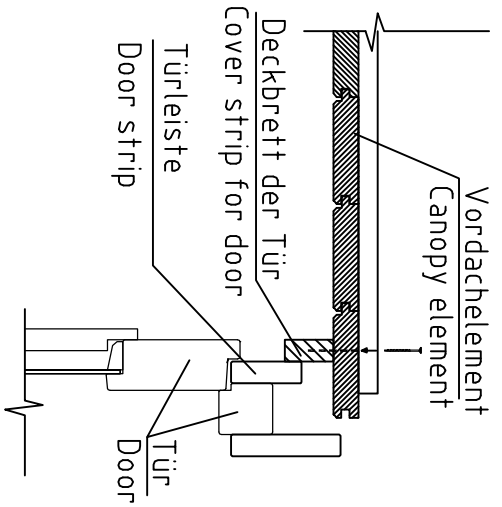

Step 3: Die Verkleidungsleisten in die richtige Länge schneiden und unter das VD-Element befestigen.
Step 3: Cut trim strips to size and fasten under the canopy element.

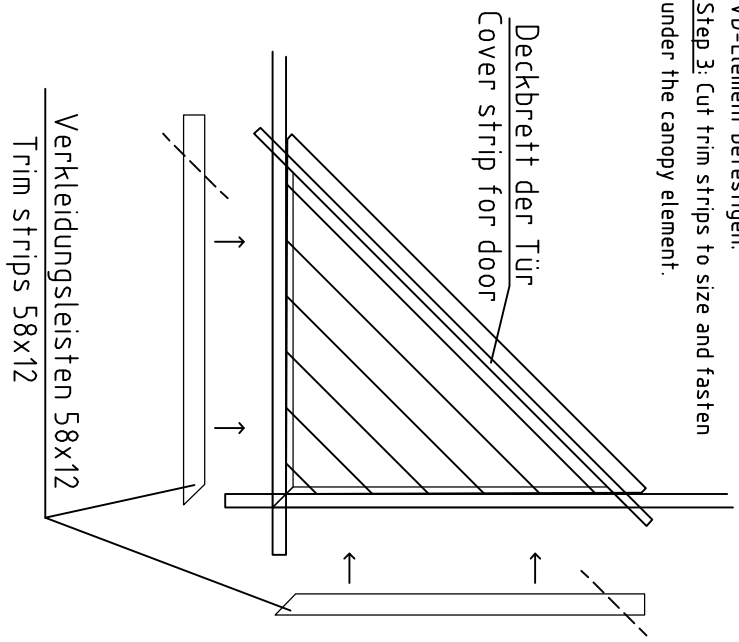

Vordachelement/Canopy element

Schnitt/Section