

House	Carin 44B	Sheet	1
Drawing	3D	Scale	
Material	44X135	Date	22.09.2020
Drawer	RP	File	Carin 44B 3D.dwg

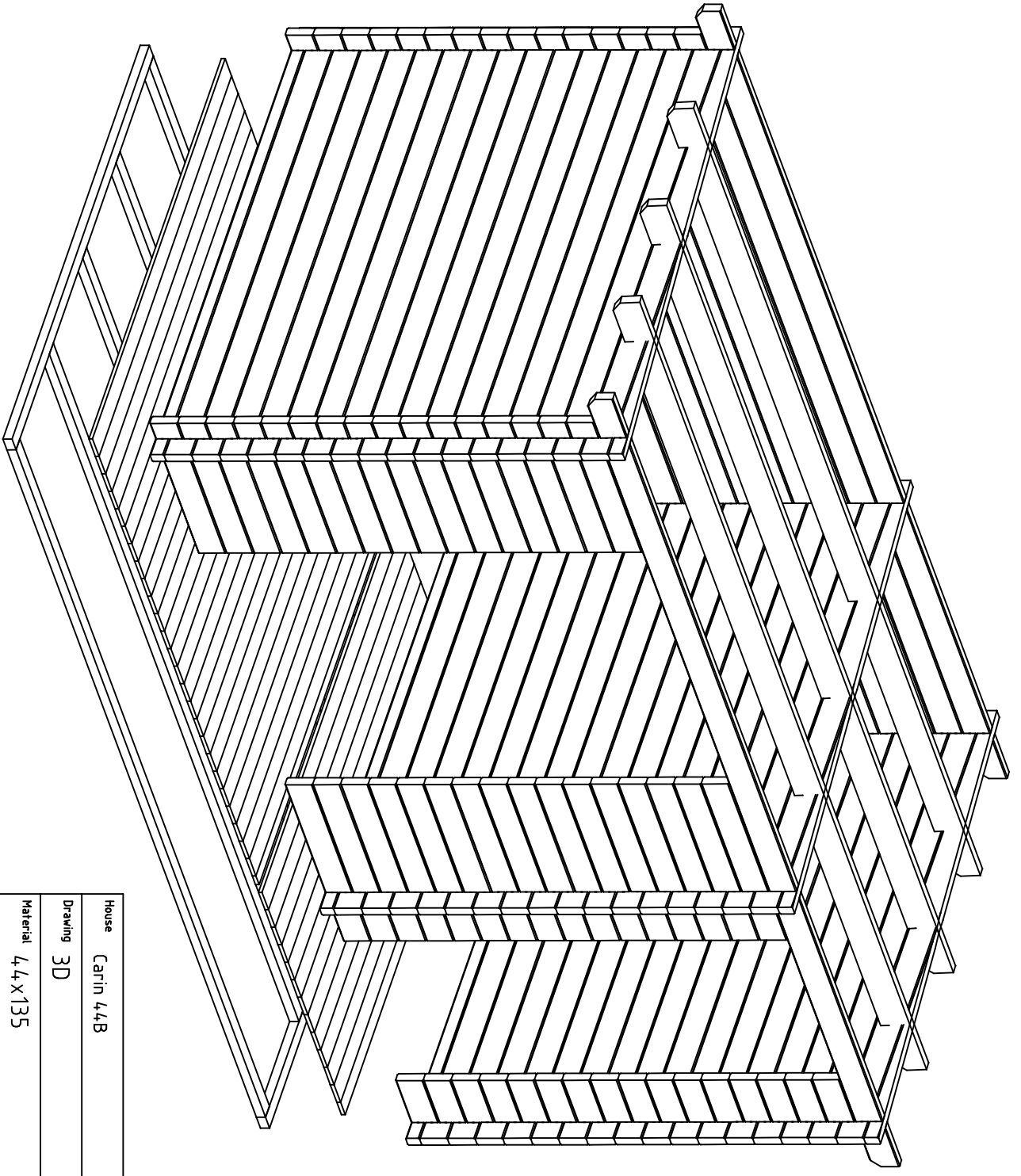

House	Carlin 44B	Sheet	2
Drawing	3D	Scale	
Material	44x135	Date	22.09.2020
Drawer	RP	File	Carlin 44B 3D.dwg

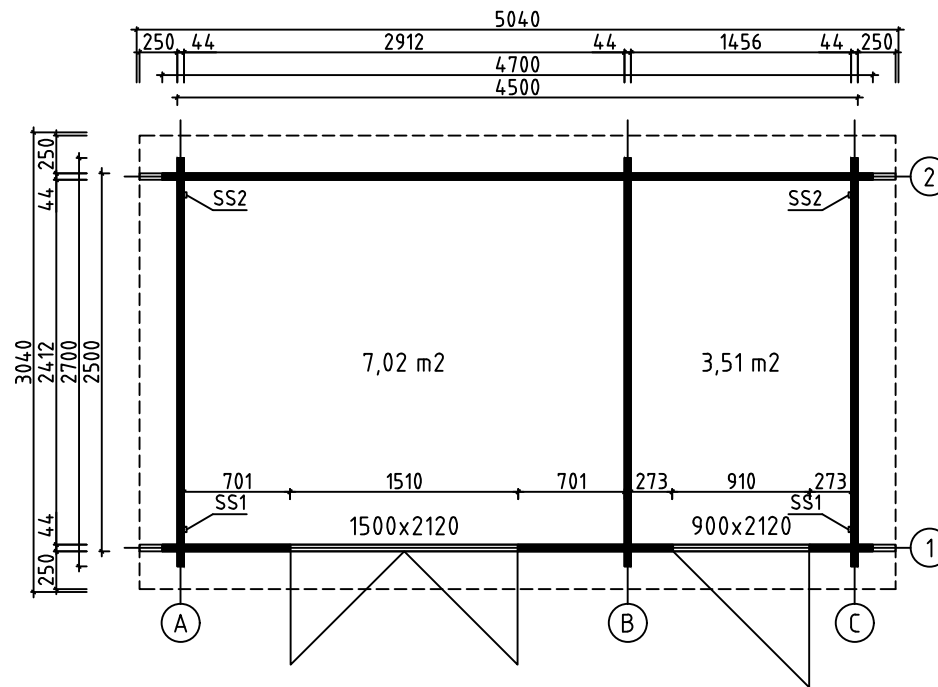

House	Carin 44B	Sheet	3
Drawing	GRUNDPLAN-GRUNDPLAN-PLAN	Scale	1:50
Material	44x135	Date	22.09.2020
Drawer	RP	File	Carin 44B.dwg

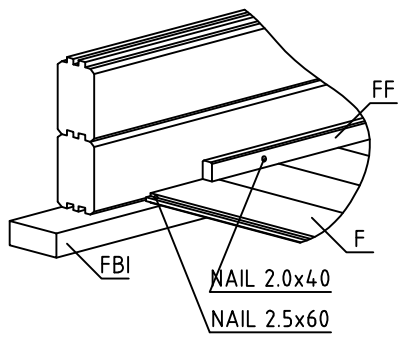
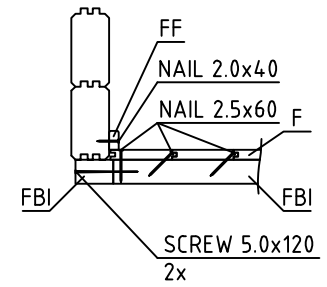
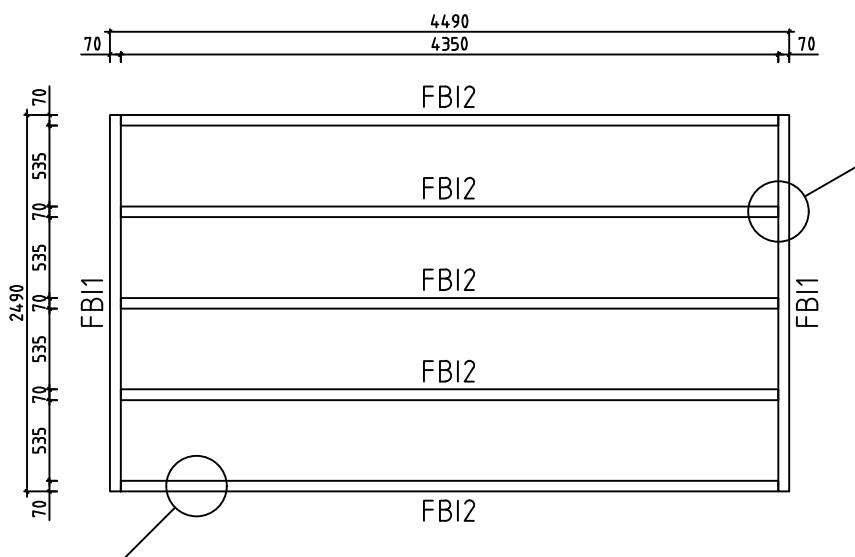

House	Carin 44B	Sheet	4
Drawing	FLOORBEAMS-FUSSBODENBALKEN-VLOERBALKEN	Scale	1:50
Material	70x45	Date	22.09.2020
Drawer	RP	File	Carin 44B.dwg

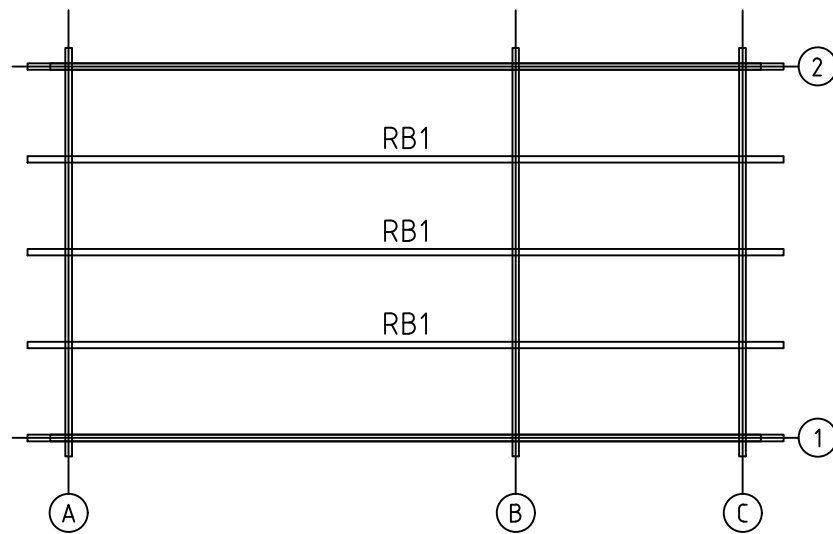

House	Carin 44B	Sheet	5
Drawing	ROOFBEAMS-DACHBALKEN-DAKBALK	Scale	1:50
Material	43x140	Date	22.09.2020
Drawer	RP	File	Carin 44B.dwg

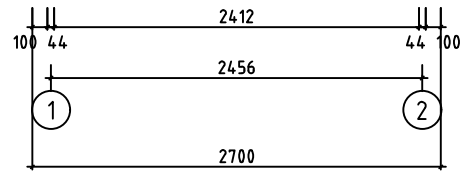
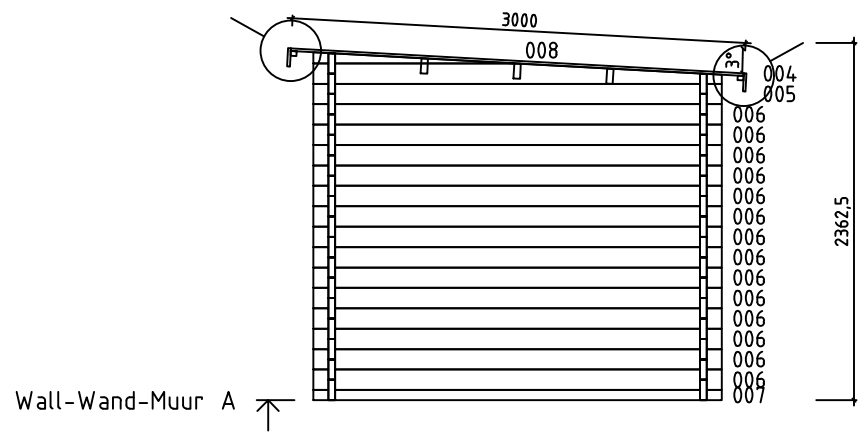
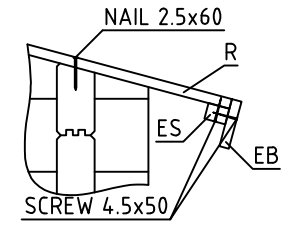
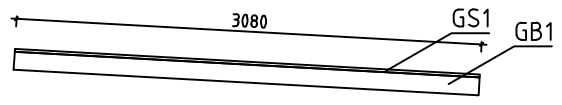
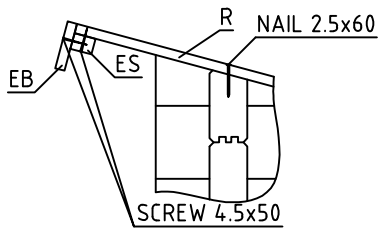

House	Carin 44B	Sheet	6
Drawing	WALL-WAND-MUUR A	Scale	1:50
Material	44x135	Date	22.09.2020
Drawer	RP	File	Carin 44B.dwg

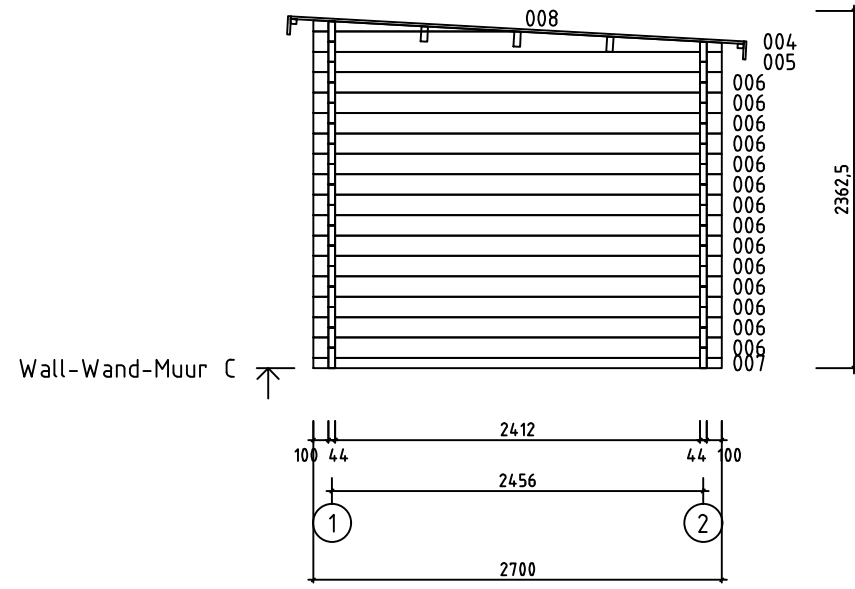

House	Carin 44B	Sheet	8
Drawing	WALL-WAND-MUUR C	Scale	1:50
Material	44x135	Date	22.09.2020
Drawer	RP	File	Carin 44B.dwg

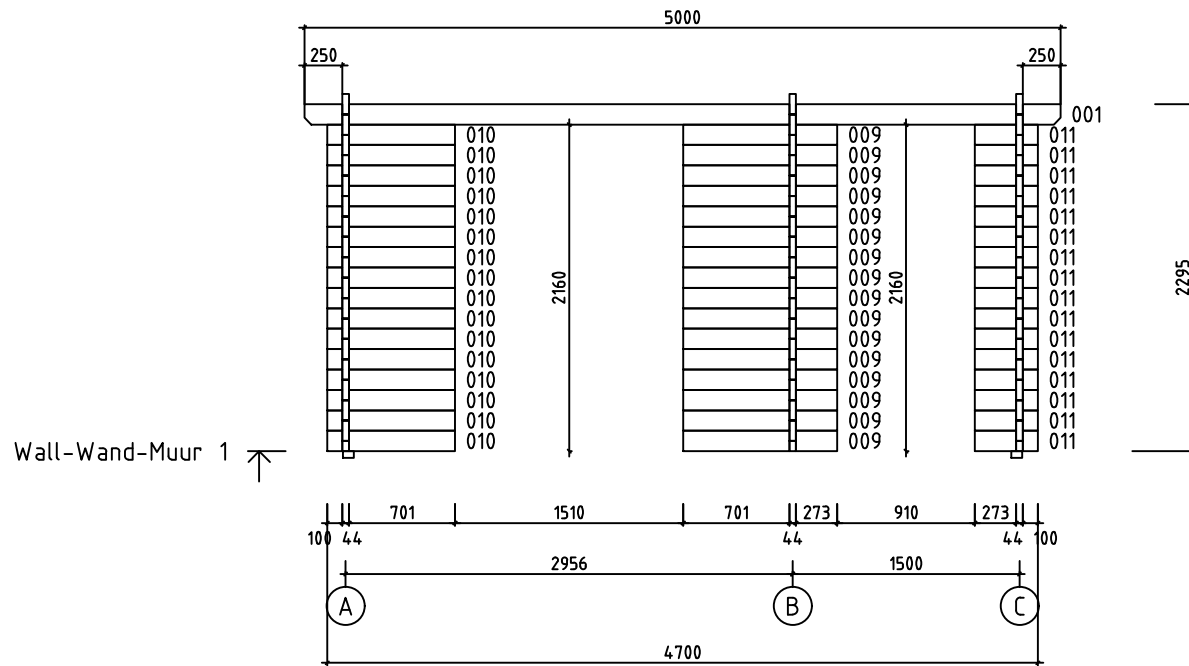





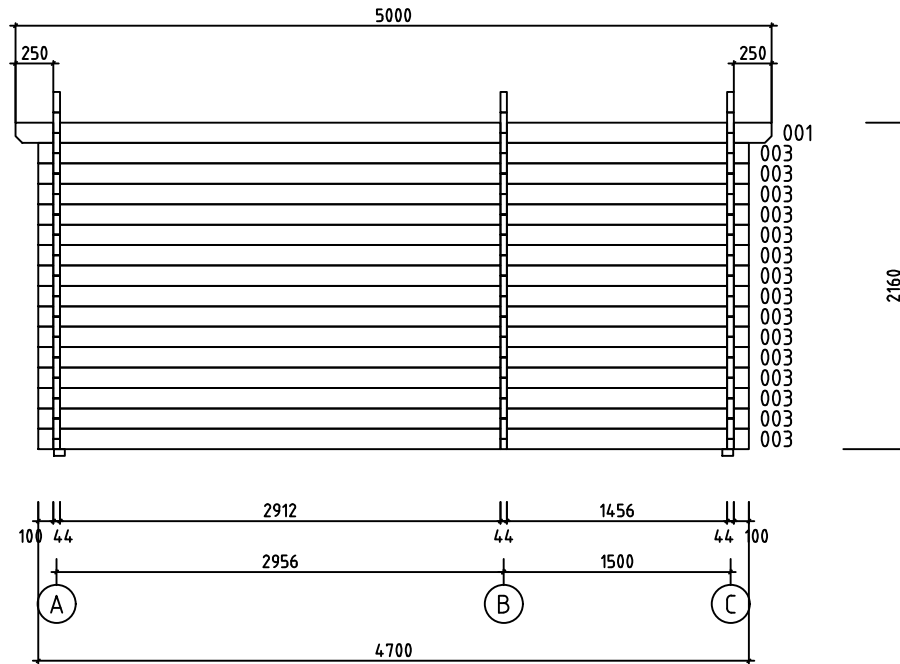



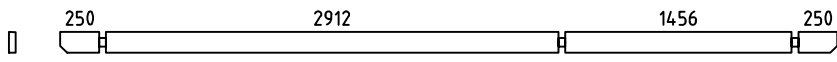
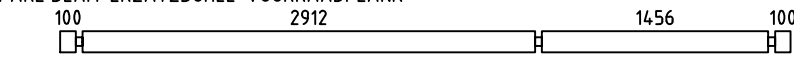
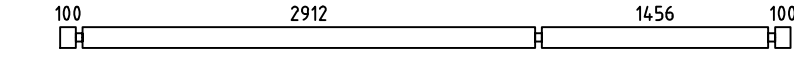
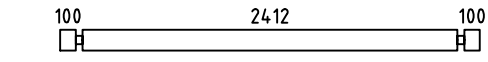
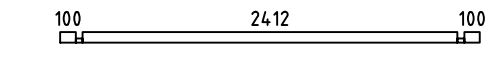
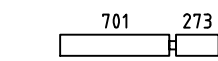
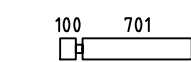
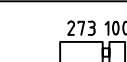
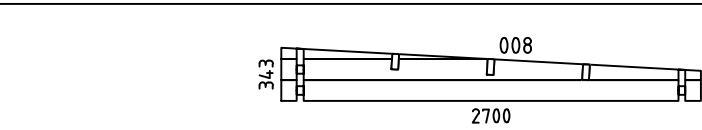

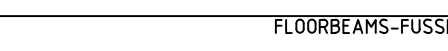
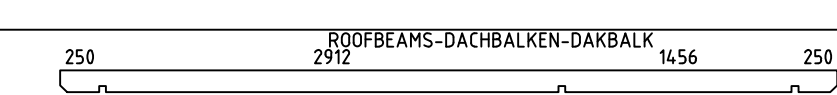







House	Carin 44B	Sheet	9
Drawing	WALL-WAND-MUUR 1	Scale	1:50
Material	44x135	Date	22.09.2020
Drawer	RP	File	Carin 44B.dwg

Wall-Wand-Muur 2 ↗



House	Carin 44B	Sheet	10
Drawing	WALL-WAND-MUUR 2	Scale	1:50
Material	44x135	Date	22.09.2020
Drawer	RP	File	Carin 44B.dwg

Pos	Specification-Bestimmung-Omschrijving	Pcs	Profile (mm)	L (mm)	
001		2	44x135	5000	
002	SPARE BEAM-ERZATZBOHLE-VOORRAADPLANK 	1	44x135	4700	
003		15	44x135	4700	
006		42	44x135	2700	
007		3	44x68	2700	
009		16	44x135	1018	
010		16	44x135	845	
011		16	44x135	417	
WA-1 WB-1 WC-1		3	44x343	2700	
HB	HIT BLOCK-SCHLAGHÖLZER-BLAZENPLANK 	2	44x135	300	
FBI2	FLOORBEAMS-FUSSBODENBALKEN-VLOERBALKEN 	IMM	70x45	4350	
FBI1	FLOORBEAMS-FUSSBODENBALKEN-VLOERBALKEN 	IMM	70x45	2490	
RB1	ROOFBEAMS-DACHBALKEN-DAKBALK 	3	43x140	5000	
F1	FLOORBOARD-FUSSBODENBRETT-VLOERPLANK  or-oder-of	39+1 51+1	18x114 18x88	2405	
R1	ROOFBOARD-DACHBRETT-DAKPLANK  or-oder-of	44+1 57+1	18x114 18x88	3000	
FF1	FLOOR FILLET-FUSSBODENLEISTE-VLOERPLINT 		18x35	19m	
GB1	GABLE BOARD-GIEBELBLENDE-GEVELPLANK 	2	18x120	3080	
GS1	ROOF FELT FILLET-GIEBELLEISTE-GEVELLIJST 	2	18x70	3080	
EB1	EAVE BOARD-TRAUFBRETT-AFDEKPLANK 	4	18x120	2500	
ES1	EAVE SLAT-TRAUFENLEISTE-AFDEKLIJST 	4	30x40	2500	
SS1	STORM SLAT-STURMLEISTE-STORMLIJST 	2	18x35	2160	
SS2	STORM SLAT-STURMLEISTE-STORMLIJST 	2	18x35	2060	
	SCREWS-SCHRAUBEN-SCHROEF FOR-FÜR-VOOR SS1, SS2 	12	Ø6.0	50	
	WASHER-SCHEIBE-SCHIJF FOR-FÜR-VOOR SS1, SS2 	12	Ø6.0	18	
House	Carin 44B	Material	File	Carin 44B.dwg	Sheet 11

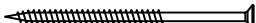
Pos	Specification-Bestimmung-Omschrijving	Pcs	Profile (mm)	L (mm)		
	NAIL-NAGEL-NAGEL FOR-FÜR-VOOR FF1 	40	∅2.0	40		
	NAIL-NAGEL-NAGEL FOR-FÜR-VOOR F1, R1 	550	∅2.5	60		
	SCREWS-SCHRAUBEN-SCHROEF FOR-FÜR-VOOR GB1, GS1, EB1, ES1 	50	∅4.5	50		
	SCREWS-SCHRAUBEN-SCHROEF FOR-FÜR-VOOR 007 	10	∅4.5	90		
	SCREWS-SCHRAUBEN-SCHROEF FOR-FÜR-VOOR FBI1, FBI2 	20	∅5.0	120		
	SCREWS-SCHRAUBEN-SCHROEF FOR-FÜR-VOOR RB1 	9	∅6.0	160		
	DOUBLEDOR SELECTABLE-DOPPELTÜR WÄHLBAR-DUBBELE DEUR SELECTEERBAAR	1	1500	2120		
	DOOR SELECTABLE-TÜR WÄHLBAR-DEUR SELECTEERBAAR	1	900	2120		
House	Carin 44B	Material	File	Carin 44B.dwg	Sheet	12

#001	1,2	5000	2
#002		4700	1
#003	2	4700	15
#004	A,B,C	2700	3
#005	A,B,C	2700	3
#006	A,B,C	2700	42
#007	A,B,C	2700	3
#008	A,B,C	1328	3
#009	1	1018	16
#010	1	845	16
#011	1	417	16