

| | | | |
|----------|---------|-------|----------------|
| House | 2826680 | Sheet | 1 |
| Drawing | 3D | Scale | |
| Material | 28x135 | Date | 27.12.2023 |
| Drawer | RP | File | 2826680_3D.dwg |

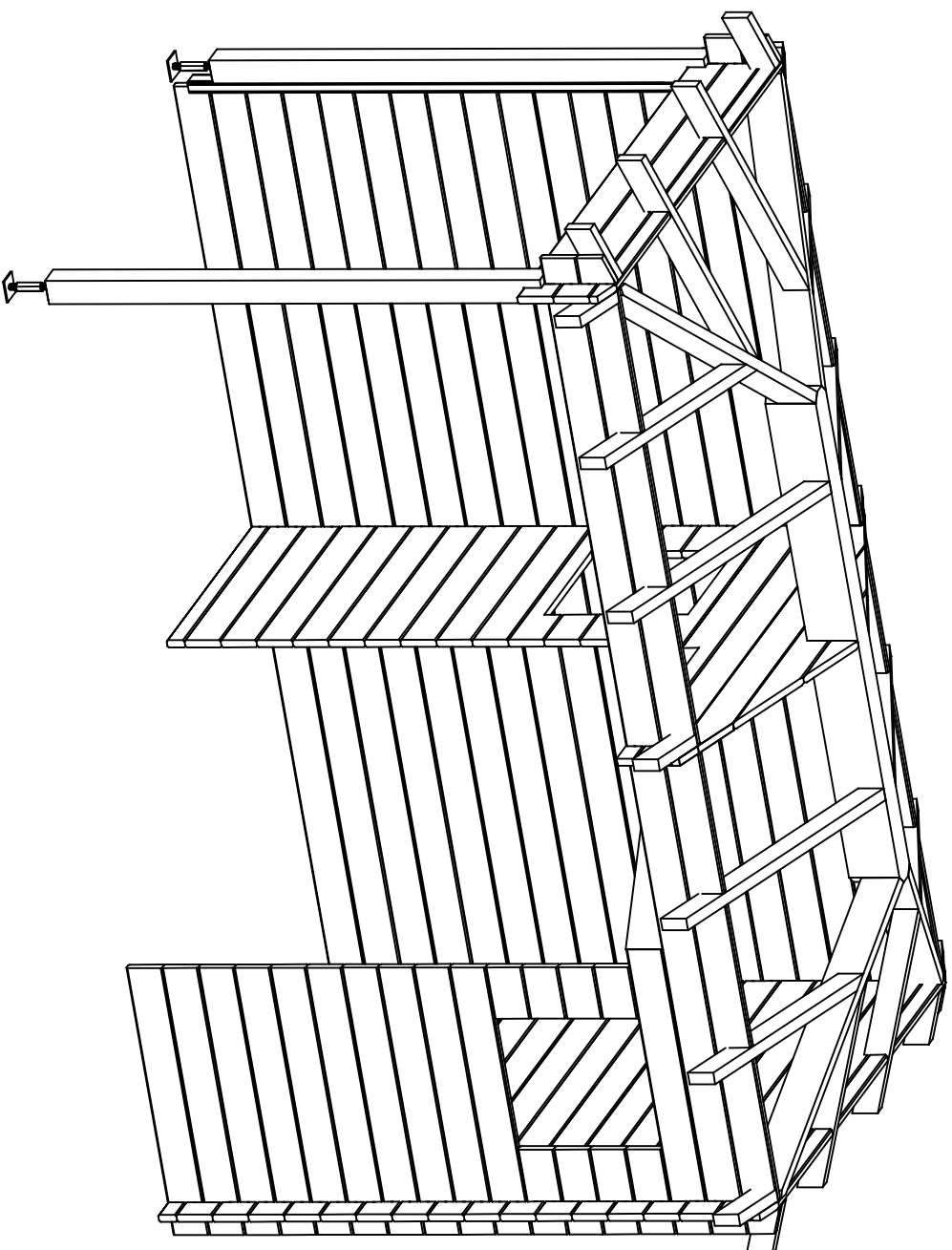

| | | | |
|----------|---------|-------|----------------|
| House | 2826680 | Sheet | 2 |
| Drawing | 3D | Scale | |
| Material | 28x135 | Date | 27.12.2023 |
| Drawer | RP | File | 2826680_3D.dwg |

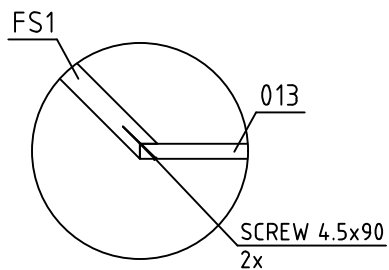
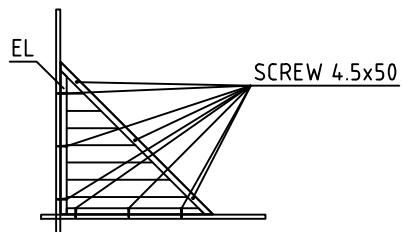
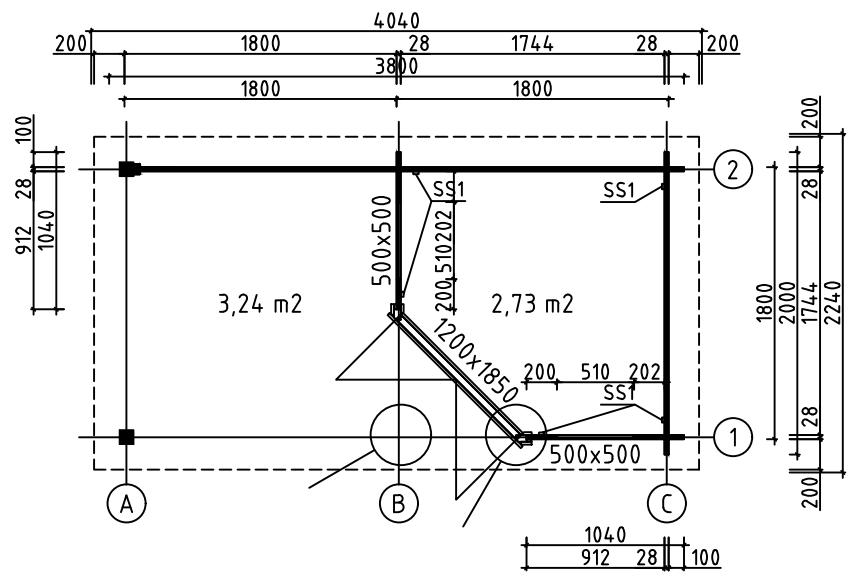

| | | | |
|----------|--------------------------|-------|-------------|
| House | 2826680 | Sheet | 3 |
| Drawing | GRUNDPLAN-GRUNDPLAN-PLAN | Scale | 1:50 |
| Material | 28x135 | Date | 27.12.2023 |
| Drawer | RP | File | 2826680.dwg |

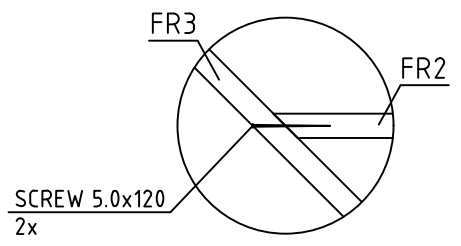
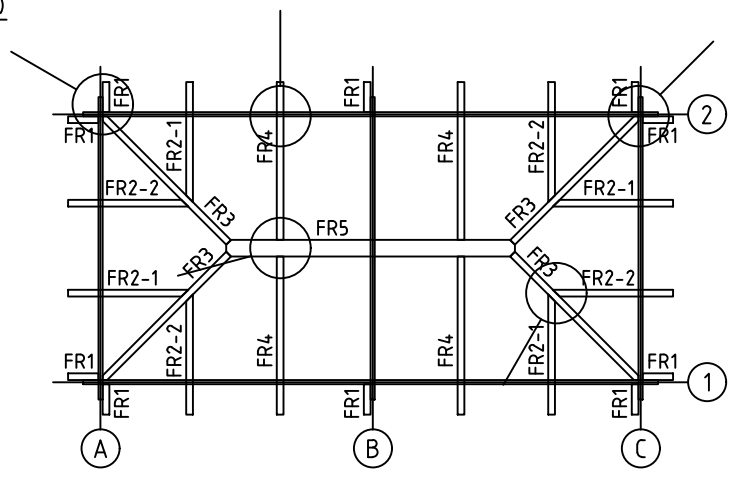
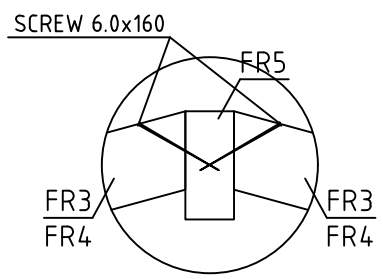
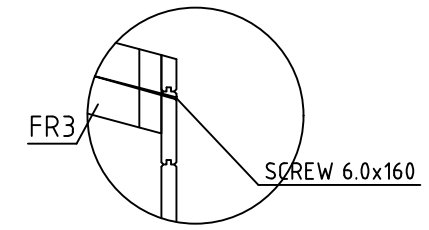
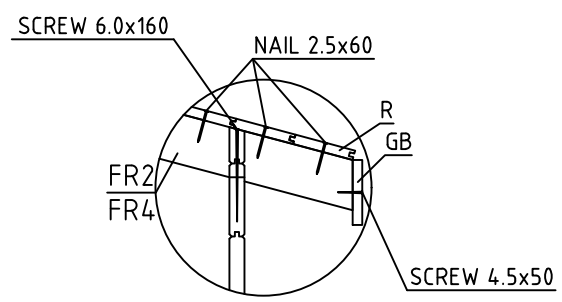
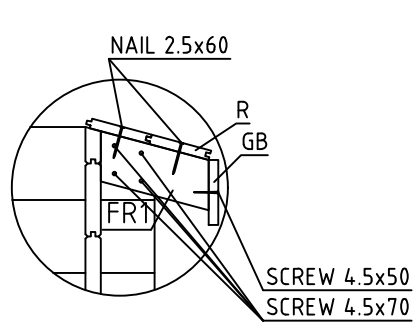

| | | | |
|----------|------------------------------|-------|-------------|
| House | 2826680 | Sheet | 4 |
| Drawing | ROOFBEAMS-DACHBALKEN-DAKBALK | Scale | 1:50 |
| Material | 43x140, 45x90 | Date | 27.12.2023 |
| Drawer | RP | File | 2826680.dwg |

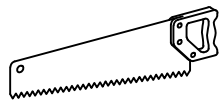
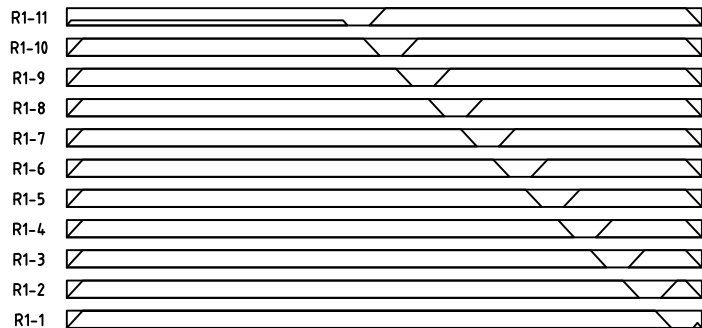
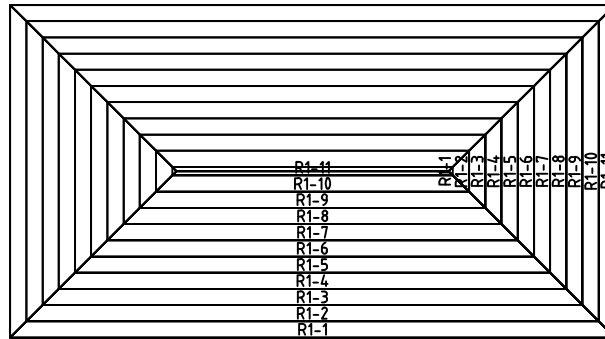

| | | | |
|----------|------------------------------|-------|-------------|
| House | 2826680 | Sheet | 5 |
| Drawing | ROOFBOARD-DACHBRETT-DAKPLANK | Scale | 1:50 |
| Material | 18x114 | Date | 27.12.2023 |
| Drawer | RP | File | 2826680.dwg |

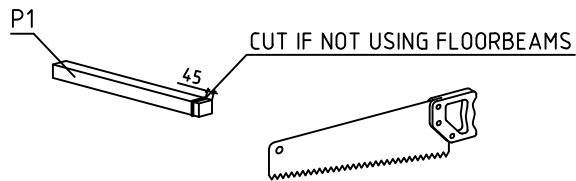
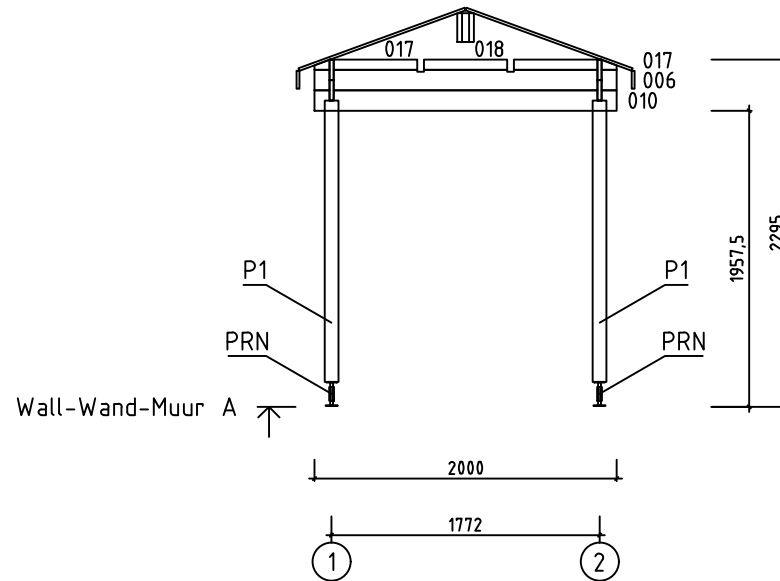

| | | | |
|----------|------------------|-------|-------------|
| House | 2826680 | Sheet | 6 |
| Drawing | WALL-WAND-MUUR A | Scale | 1:50 |
| Material | 28x135 | Date | 27.12.2023 |
| Drawer | RP | File | 2826680.dwg |

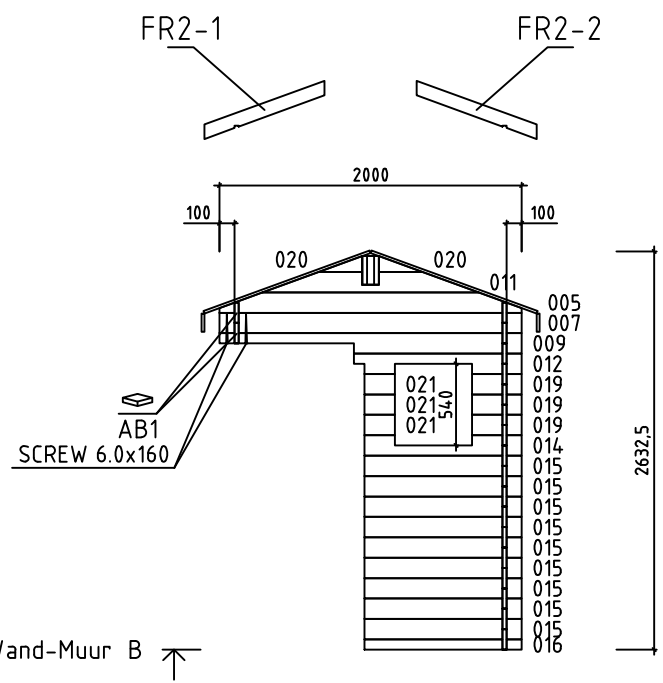

Wall-Wand-Muur B ↗

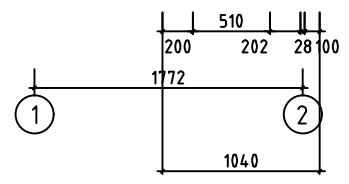

| | | | |
|----------|------------------|-------|-------------|
| House | 2826680 | Sheet | 7 |
| Drawing | WALL-WAND-MUUR B | Scale | 1:50 |
| Material | 28x135 | Date | 27.12.2023 |
| Drawer | RP | File | 2826680.dwg |

FR1

FR1

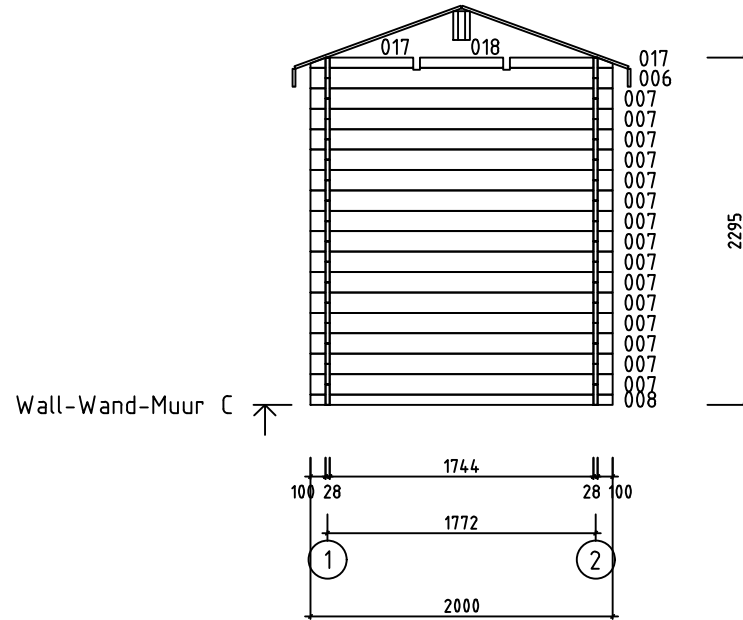



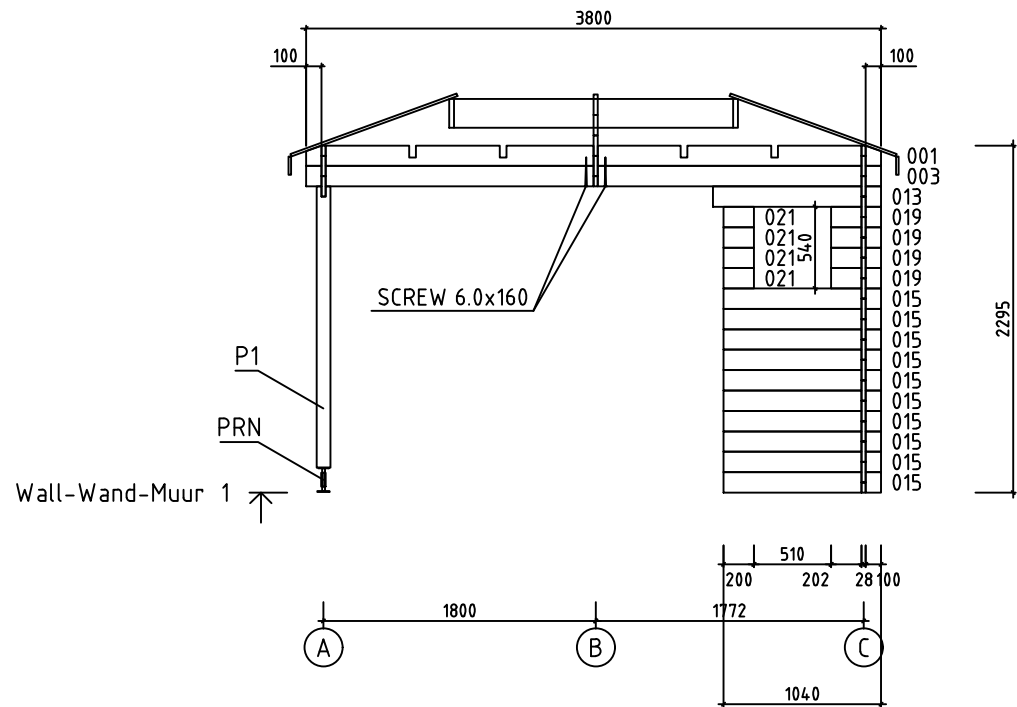

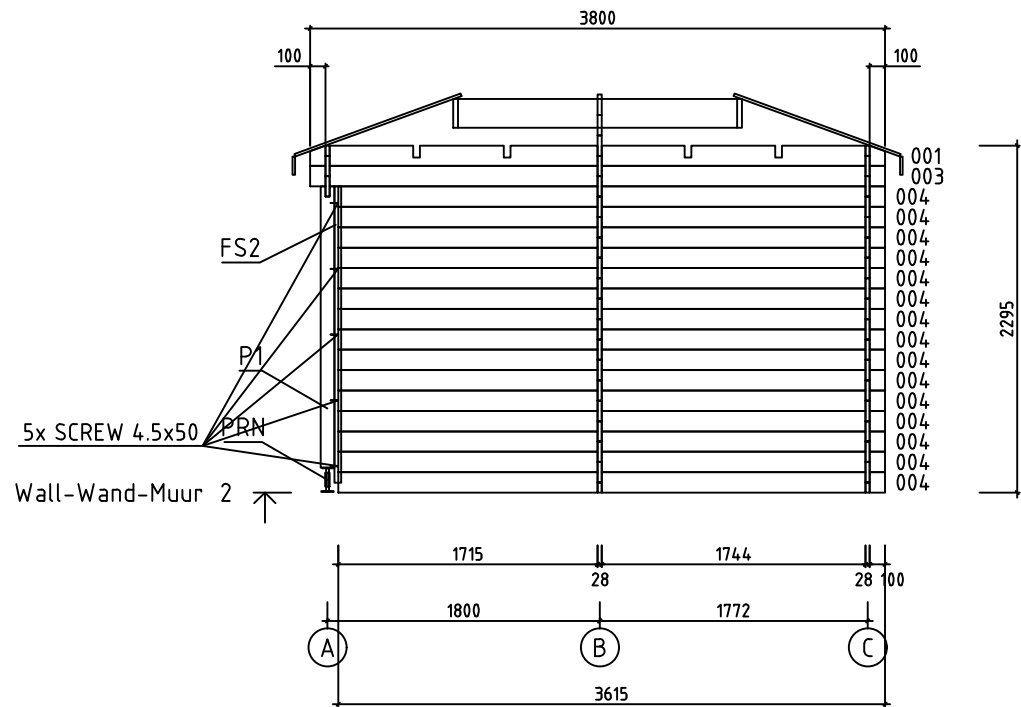

| | | | |
|----------|------------------|-------|-------------|
| House | 2826680 | Sheet | 8 |
| Drawing | WALL-WAND-MUUR C | Scale | 1:50 |
| Material | 28x135 | Date | 27.12.2023 |
| Drawer | RP | File | 2826680.dwg |



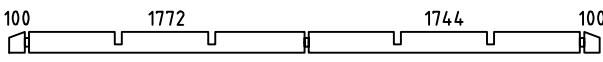
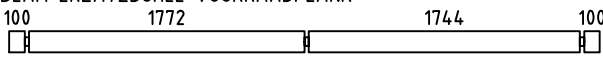
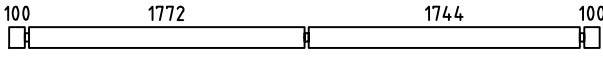
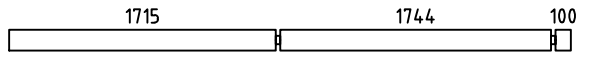
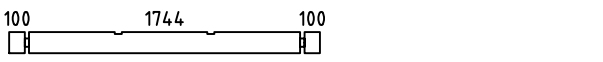
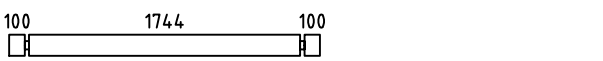
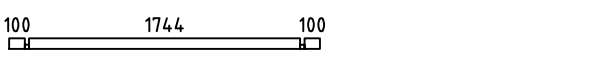
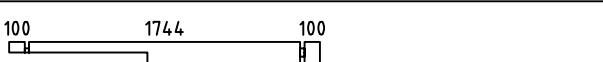
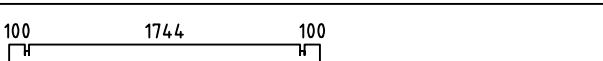

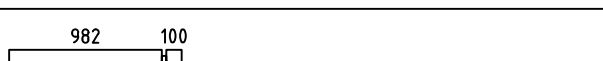
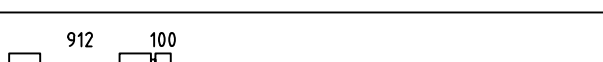
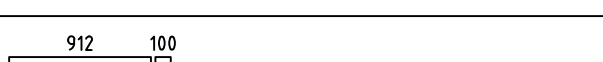
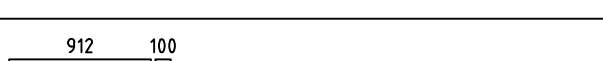
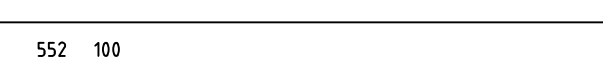
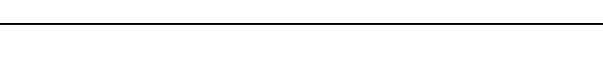
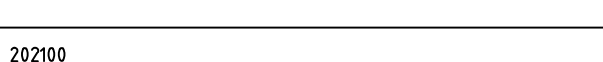
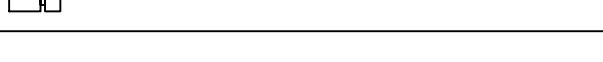
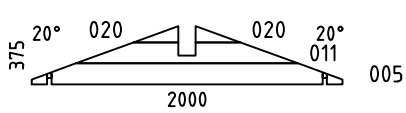

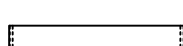

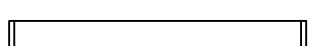

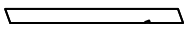
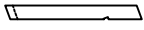
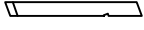

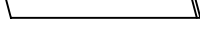



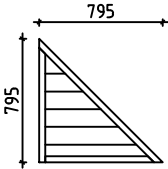

| | | | |
|----------|------------------|-------|-------------|
| House | 2826680 | Sheet | 9 |
| Drawing | WALL-WAND-MUUR 1 | Scale | 1:50 |
| Material | 28x135 | Date | 27.12.2023 |
| Drawer | RP | File | 2826680.dwg |



| | | | |
|----------|------------------|-------|-------------|
| House | 2826680 | Sheet | 10 |
| Drawing | WALL-WAND-MUUR 2 | Scale | 1:50 |
| Material | 28x135 | Date | 27.12.2023 |
| Drawer | RP | File | 2826680.dwg |

| Pos | Specification-Bestimmung-Omschrijving | Pcs | Profile (mm) | L (mm) | | |
|-------|---|----------|--------------|-------------|-------|----|
| 001 |  PM | 2 | 28x135 | 3800 | | |
| 002 | SPARE BEAM-ERZATZBOHLE-VOORRAADPLANK  | 1 | 28x135 | 3800 | | |
| 003 |  | 2 | 28x135 | 3800 | | |
| 004 |  | 15 | 28x135 | 3615 | | |
| 006 |  | 2 | 28x135 | 2000 | | |
| 007 |  | 16 | 28x135 | 2000 | | |
| 008 |  | 1 | 28x68 | 2000 | | |
| 009 |  | 1 | 28x135 | 2000 | | |
| 010 |  | 1 | 28x135 | 2000 | | |
| 012 |  | 1 | 28x135 | 1110 | | |
| 013 |  | 1 | 28x135 | 1110 | | |
| 014 |  | 1 | 28x135 | 1040 | | |
| 015 |  | 19 | 28x135 | 1040 | | |
| 016 |  | 1 | 28x68 | 1040 | | |
| 017 |  | 4 | 28x68 | 680 | | |
| 018 |  | 2 | 28x68 | 550 | | |
| 019 |  | 7 | 28x135 | 330 | | |
| 021 |  | 7 | 28x135 | 200 | | |
| WB-1 |  | 1 | 28x375 | 2000 | | |
| HB | HIT BLOCK-SCHLAGHÖLZER-BLAZENPLANK  | 2 | 28x135 | 300 | | |
| FS2 | FIXING SLAT-BEFESTIGUNGSLEISTE-BEVESTIGING PLINT  | 1 | 45x70 | 1960 | | |
| FS1 | FIXING SLAT-BEFESTIGUNGSLEISTE-BEVESTIGING PLINT  | 1 | 43x140 | 1125 | | |
| P1 | POST-PFOSTEN-STUT  | 2 | 90x90 | 1905 | | |
| FR5 | ROOFBEAMS-DACHBALKEN-DAKBALK  | 1 | 110x190 | 1910 | | |
| House | 2826680 | Material | File | 2826680.dwg | Sheet | 11 |

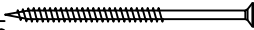
| Pos | Specification-Bestimmung-Omschrijving | Pcs | Profile (mm) | L (mm) |
|---------------|---|------------------|-----------------|--------|
| FR4 | RAFTER-SPARREN-DAKSPAR  | 4 | 45x90 | 1144 |
| FR2-1 | RAFTER-SPARREN-DAKSPAR  | 4 | 45x90 | 878 |
| FR2-2 | RAFTER-SPARREN-DAKSPAR  | 4 | 45x90 | 878 |
| FR1 | RAFTER-SPARREN-DAKSPAR  | 10 | 45x90 | 245 |
| FR3 | RAFTER-SPARREN-DAKSPAR  | 4 | 43x140 | 1255 |
| R1 | ROOFBOARD-DACHBRETT-DAKPLANK  or-oder-of | 22+2 30+2 | 18x114 18x88 | 4200 |
| GB1 | GABLE BOARD-GIEBELBLENDE-GEVELPLANK  | 2 | 18x120 | 4020 |
| GB2 | GABLE BOARD-GIEBELBLENDE-GEVELPLANK  | 2 | 18x120 | 2220 |
| AB1 | ASSEMBLING BOARD-MONTAGE BOARD-MONTAGE PLANK  | 2 | 15x20 | 20 |
| EL | ELEMENT-ELEMENTE-ELEMENTEN  | 1 | 48x795 | 795 |
| SS1 | STORM SLAT-STURMLEISTE-STORMLIJST  | 5 | 18x35 | 2160 |
| PRN | POST REGULATOR-PFOSTEN REGLER-STUT REGELAAR  | 2 | | |
| | SCREWS-SCHRAUBEN-SCHROEF FOR-FÜR-VOOR SS1  | 15 | ø6.0 | 50 |
| | WASHER-SCHEIBE-SCHIJF FOR-FÜR-VOOR SS1  | 15 | ø6.0 | 18 |
| | NAIL-NAGEL-NAGEL FOR-FÜR-VOOR R1  | 280 | ø2.5 | 60 |
| | SCREWS-SCHRAUBEN-SCHROEF FOR-FÜR-VOOR GB1, GB2, EL, FS2, P1  | 40 | ø4.5 | 50 |
| | SCREWS-SCHRAUBEN-SCHROEF FOR-FÜR-VOOR PRN  | 16 | ø6.0 | 45 |
| | SCREWS-SCHRAUBEN-SCHROEF FOR-FÜR-VOOR FR1  | 50 | ø4.5 | 70 |
| | SCREWS-SCHRAUBEN-SCHROEF FOR-FÜR-VOOR FS1, 017, 018  | 20 | ø4.5 | 90 |
| | SCREWS-SCHRAUBEN-SCHROEF FOR-FÜR-VOOR FR2-1, FR2-2  | 20 | ø5.0 | 120 |
| | SCREWS-SCHRAUBEN-SCHROEF 001, FOR-FÜR-VOOR FR2-1, FR2-2, FR3, FR4, FR5  | 40 | ø6.0 | 160 |
| | | | | |
| | | | | |
| House 2826680 | Material | File 2826680.dwg | Sheet 12 | |

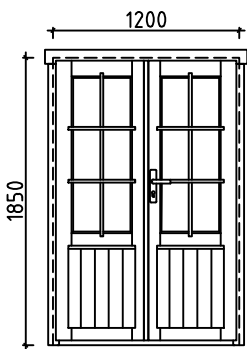
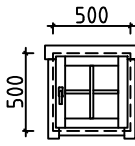
| Pos | Specification-Bestimmung-Omschrijving | Pcs | Profile (mm) | L (mm) |
|---------------|---|--|--------------|-------------|
| | <p>DOUBLEDOR-DOPPELTÜR-DUBBELE DEUR (right-rechts-rechts) AST_PL</p>  | <p>P</p> <p>1</p> <p>1</p> <p>1</p> <p>1</p> <p>6</p> <p>2</p> | <p>1200</p> | <p>1850</p> |
| | <p>WINDOW-FENSTER-VENSTER (1x right-rechts-rechts; 1x left-links-links) AST</p>  | <p>P+V</p> <p>1+1</p> <p>2</p> <p>2</p> | <p>500</p> | <p>500</p> |
| House 2826680 | Material | File 2826680.dwg | Sheet 13 | |

| | | | |
|------|-----|------|----|
| #001 | 1,2 | 3800 | 2 |
| #002 | | 3800 | 1 |
| #003 | 1,2 | 3800 | 2 |
| #004 | 2 | 3615 | 15 |
| #005 | B | 2000 | 1 |
| #006 | A,C | 2000 | 2 |
| #007 | B,C | 2000 | 16 |
| #008 | C | 2000 | 1 |
| #009 | B | 2000 | 1 |
| #010 | A | 2000 | 1 |
| #011 | B | 1429 | 1 |
| #012 | B | 1110 | 1 |
| #013 | 1 | 1110 | 1 |
| #014 | B | 1040 | 1 |
| #015 | 1,B | 1040 | 19 |
| #016 | B | 1040 | 1 |
| #017 | A,C | 680 | 4 |
| #018 | A,C | 550 | 2 |
| #019 | 1,B | 330 | 7 |
| #020 | B | 289 | 2 |
| #021 | 1,B | 200 | 7 |