

House	Schwedenhaus 28	Sheet	1
Drawing	3D	Scale	
Material	28x135	Date	27.07.2022
Drawer	RP	File	Schwedenhaus 28 3D.dwg

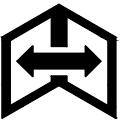

House	Schwedenhaus 28	Sheet	2
Drawing	GRUNDPLAN-GRUNDPLAN-PLAN	Scale	1:50
Material	28x135	Date	27.07.2022
Drawer	RP	File	Schwedenhaus 28.dwg

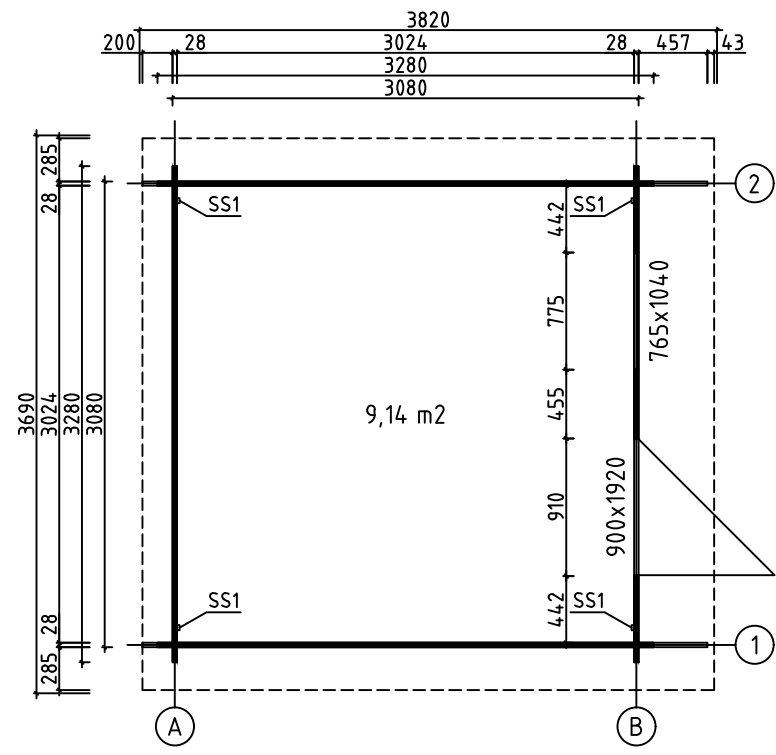

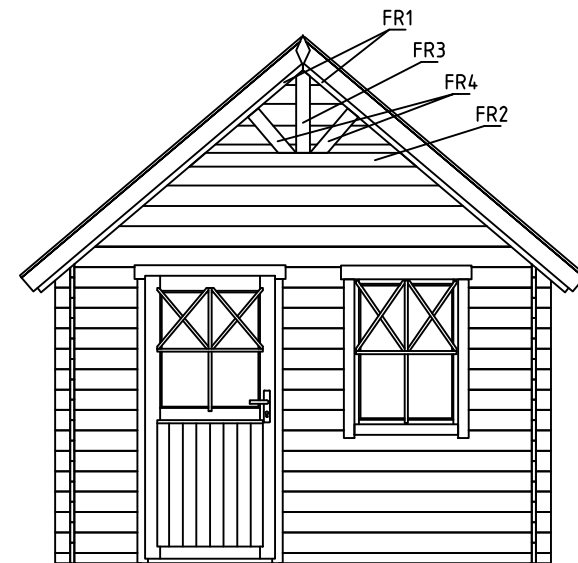
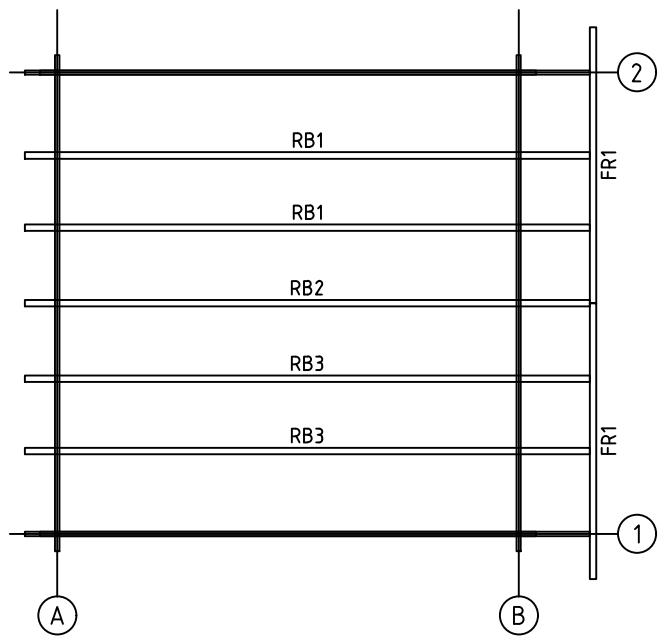

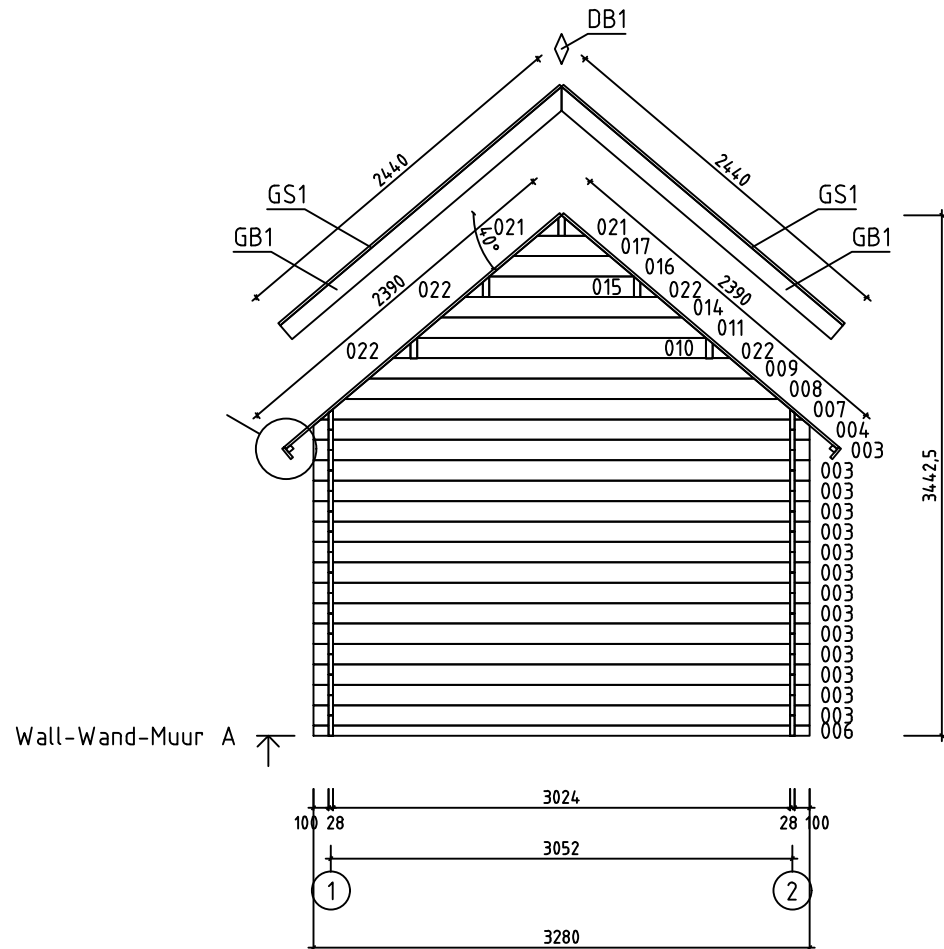
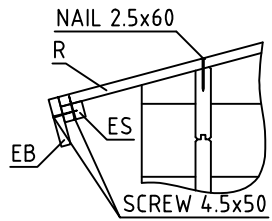



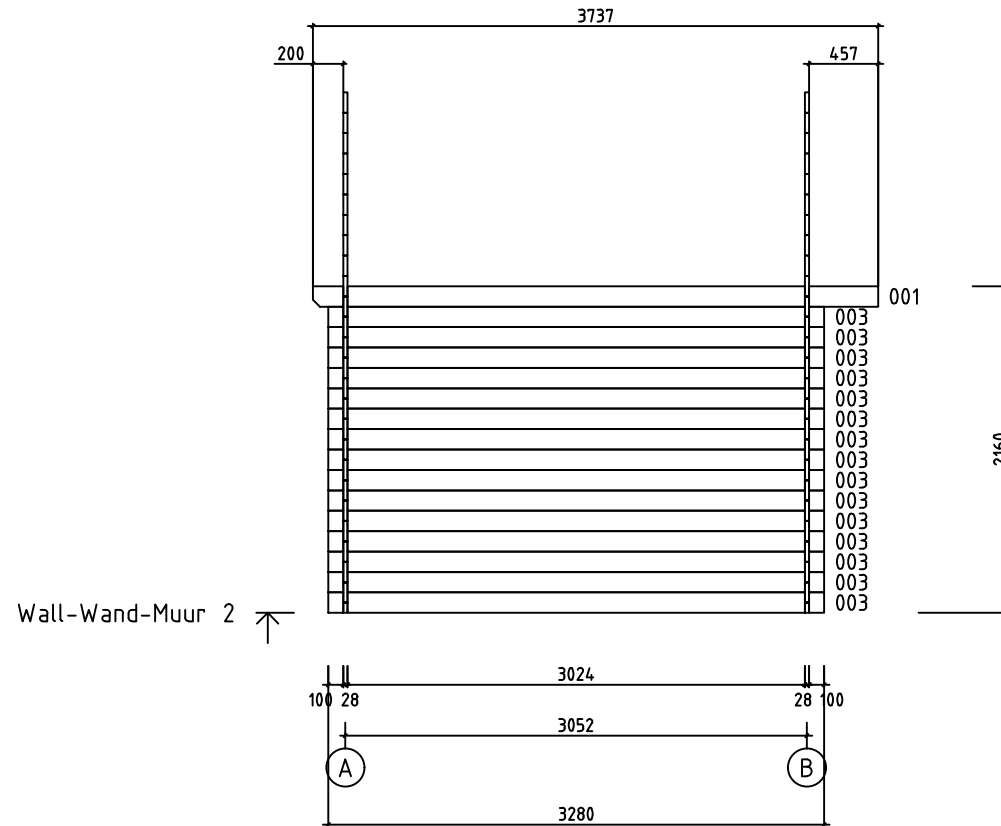

House	Schwedenhaus 28	Sheet	3
Drawing	ROOFBEAMS-DACHBALKEN-DAKBALK	Scale	1:50
Material	43x140	Date	27.07.2022
Drawer	RP	File	Schwedenhaus 28.dwg

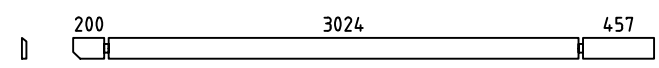
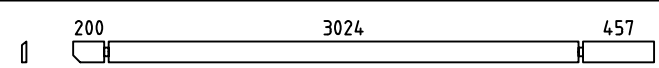
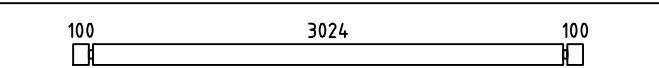

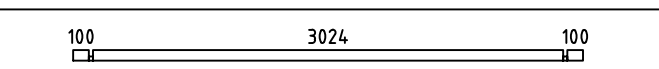
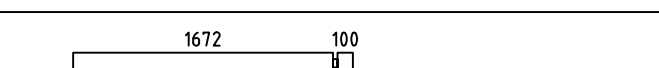
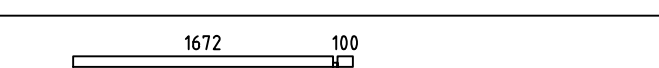
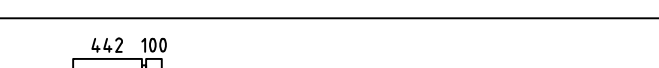
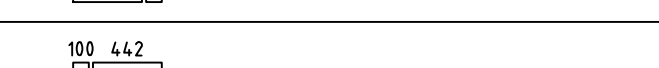
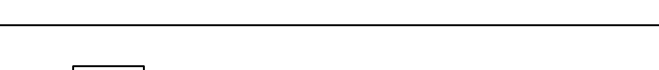
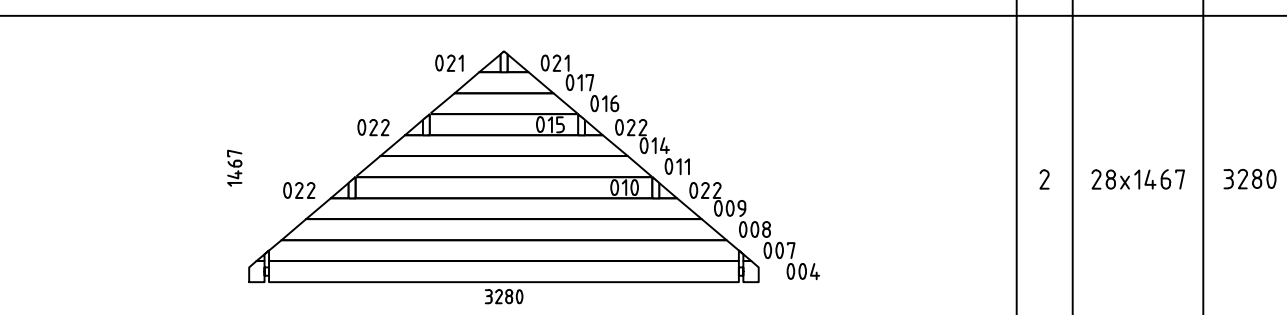

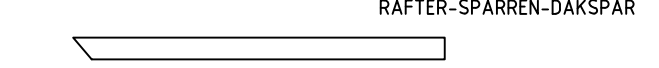
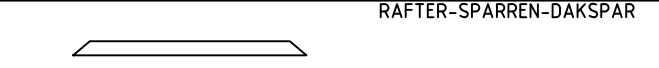
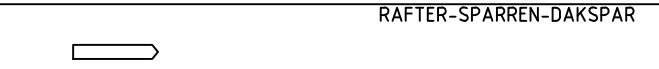
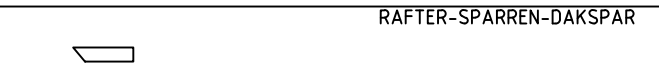
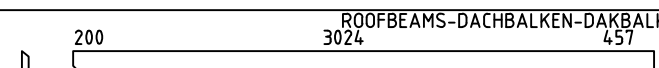
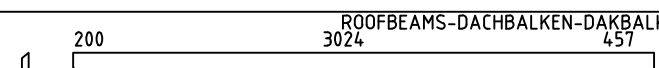
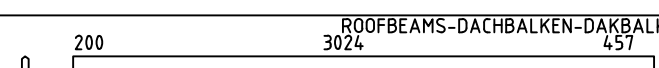

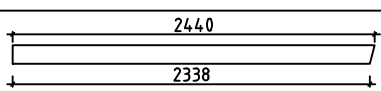







House	Schwedenhaus 28	Sheet	4
Drawing	WALL-WAND-MUUR A	Scale	1:50
Material	28x135	Date	27.07.2022
Drawer	RP	File	Schwedenhaus 28.dwg

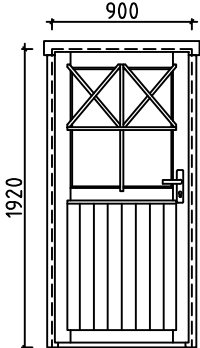
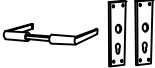

House	Schwedenhaus 28	Sheet	7
Drawing	WALL-WAND-MUUR 2	Scale	1:50
Material	28x135	Date	27.07.2022
Drawer	RP	File	Schwedenhaus 28.dwg

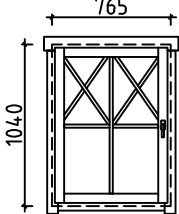
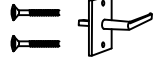
Pos	Specification-Bestimmung-Omschrijving	Pcs	Profile (mm)	L (mm)		
001		1	28x135	3737		
002		1	28x135	3737		
003		44	28x135	3280		
005	SPARE BEAM-ERZATZBOHLE-VOORRAADPLANK 	1	28x135	3280		
006		1	28x68	3280		
012		6	28x135	1800		
013		1	28x68	1800		
018		22	28x135	570		
019		1	28x68	570		
020		8	28x135	455		
WA-1 WB-1		2	28x1467	3280		
HB	HIT BLOCK-SCHLAGHÖLZER-BLAZENPLANK 	2	28x135	300		
FR1	RAFTER-SPARREN-DAKSPAR 	2	43x140	2390		
FR2	RAFTER-SPARREN-DAKSPAR 	1	43x90	1500		
FR3	RAFTER-SPARREN-DAKSPAR 	1	43x90	546		
FR4	RAFTER-SPARREN-DAKSPAR 	2	43x90	387		
RB1	ROOFBEAMS-DACHBALKEN-DAKBALK 	2	43x140	3737		
RB3	ROOFBEAMS-DACHBALKEN-DAKBALK 	2	43x140	3737		
RB2	ROOFBEAMS-DACHBALKEN-DAKBALK 	1	43x140	3737		
R1	ROOFBOARD-DACHBRETT-DAKPLANK  or-oder-of	68+2 88+2	18x114 18x88	2390		
GB1	GABLE BOARD-GIEBELBLLENDE-GEVELPLANK 	4	18x120	2440		
GS1	ROOF FELT FILLET-GIEBELLEISTE-GEVELLIJST 	4	18x70	2440		
House	Schwedenhaus 28	Material	File	Schwedenhaus 28.dwg	Sheet	8

Pos	Specification-Bestimmung-Omschrijving	Pcs	Profile (mm)	L (mm)		
EB1	EAVE BOARD-TRAUFBRETT-AFDEKPLANK 	4	18x90	1890		
ES1	EAVE SLAT-TRAFENLEISTE-AFDEKLIJST 	4	30x40	1890		
DB1	DIAMOND-RAUTE-DIAMANT 	2	18x90	200		
SS1	STORM SLAT-STURMLEISTE-STORMLIJST 	4	18x35	2090		
	SCREWS-SCHRAUBEN-SCHROEF FOR-FÜR-VOOR SS1 	12	∅6.0	40		
	WASHER-SCHEIBE-SCHIJF FOR-FÜR-VOOR SS1 	12	∅6.0	18		
	NAIL-NAGEL-NAGEL FOR-FÜR-VOOR R1 	360	∅2.5	60		
	SCREWS-SCHRAUBEN-SCHROEF FOR-FÜR-VOOR GB1, GS1, EB1, ES1, DB1 	70	∅4.5	50		
	SCREWS-SCHRAUBEN-SCHROEF FOR-FÜR-VOOR FR1, FR2, FR3, FR4, RB1, RB2 	40	∅6.0	160		
	DOOR-TÜR-DEUR (left-links-links) AST_PL 	V	1	900	1920	
		1				
		1				
		1				
	WINDOW-FENSTER-VENSTER (left-links-links) AST_KP 	V	1	765	1040	
		1				
		1				
House	Schwedenhaus 28	Material	File	Schwedenhaus 28.dwg	Sheet	9

#001	2	3737	1
#002	1	3737	1
#003	1,2,A	3280	44
#004	A,B	3280	2
#005		3280	1
#006	A	3280	1
#007	A,B	3183	2
#008	A,B	2865	2
#009	A,B	2547	2
#010	A,B	1911	2
#011	A,B	1910	2
#012	B	1800	6
#013	B	1800	1
#014	A,B	1592	2
#015	A,B	956	2
#016	A,B	955	2
#017	A,B	637	2
#018	B	570	22
#019	B	570	1
#020	B	455	8
#021	A,B	138	4
#022	A,B	116	8