

Date rev. Description V 1.0

House	2813451	Sheet	1
-------	---------	-------	---

Drawing	3D	Scale	
---------	----	-------	--

Material	28X135	Date	21.08.2025
----------	--------	------	------------

Drawer	K.K.	File	2813451 3D.dwg
--------	------	------	----------------

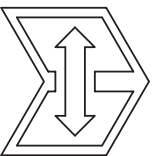
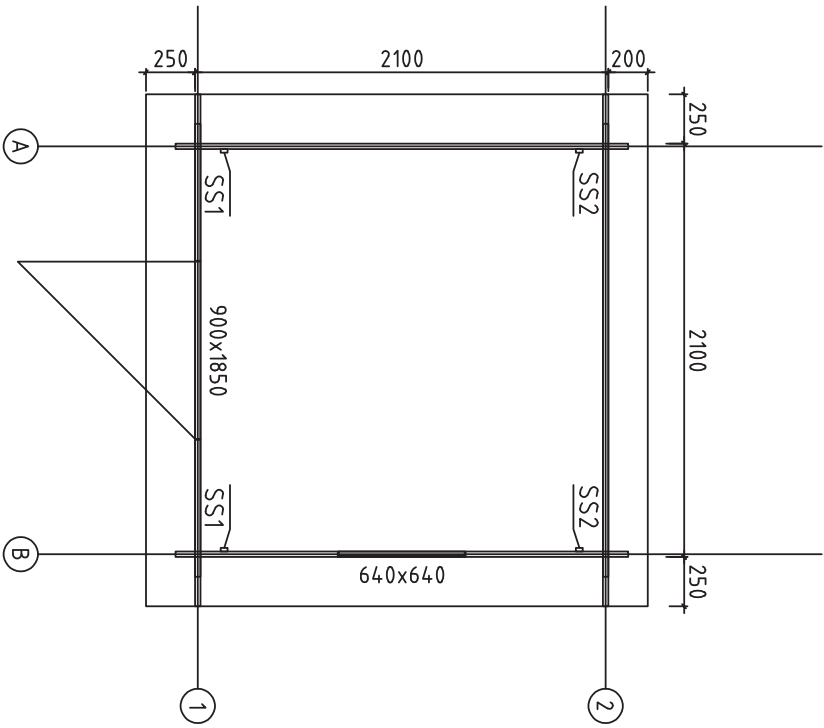

House	2813451	Sheet	2
Drawing	Plan	Scale	1:35
Material	28x135	Date	21.08.2025
Drawer	K.K.	File	2813451.dwg

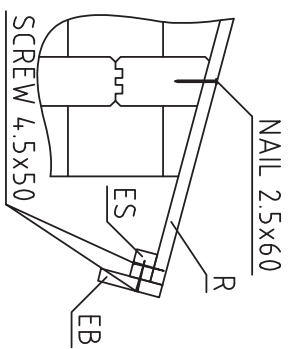
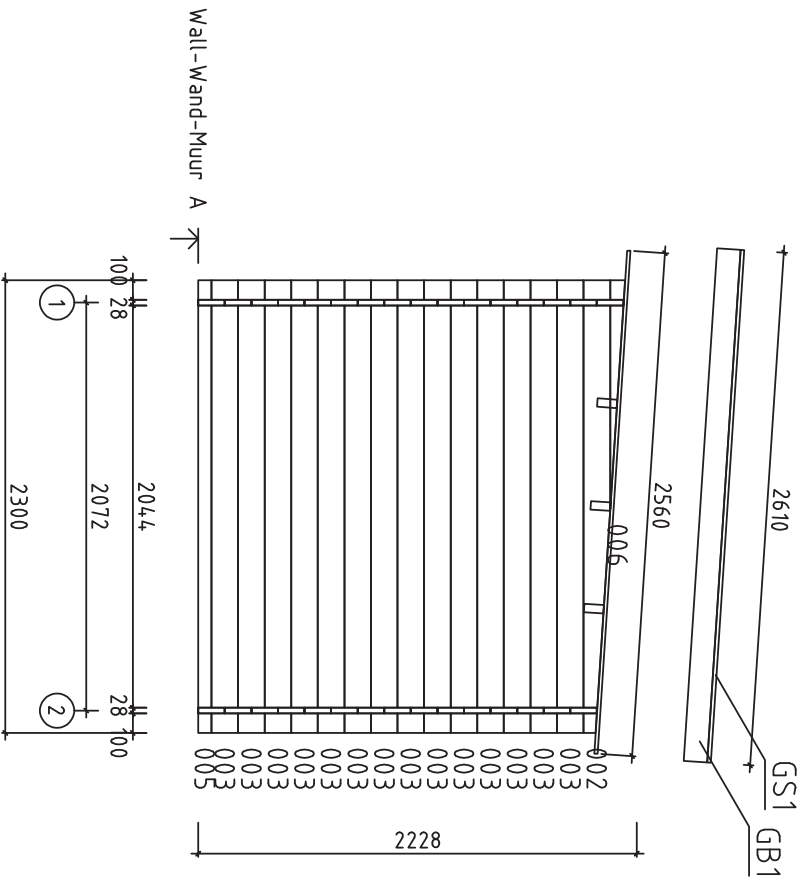

House	2813451	Sheet	3
Drawing	WALL-WAND-MUUR A	Scale	1:35
Material	2.8x13.5	Date	21.08.2025
Drawer	K.K.	File	2813451.dwg

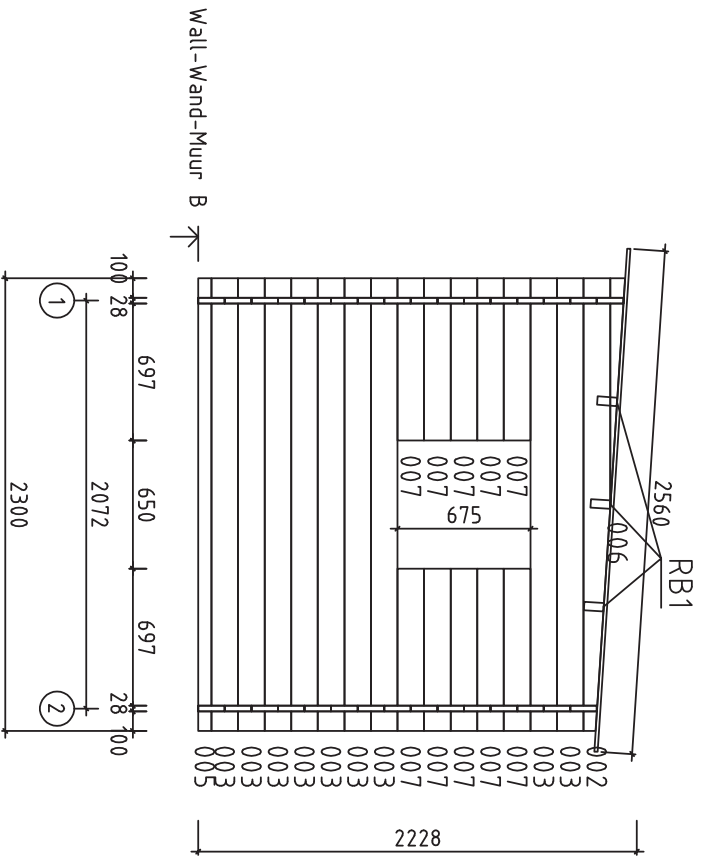



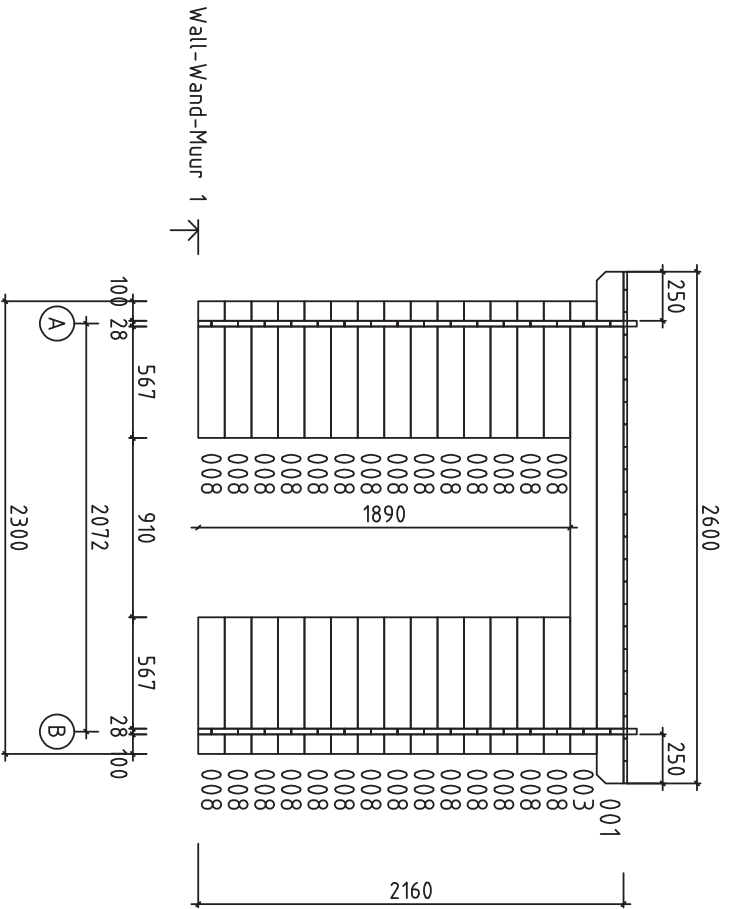





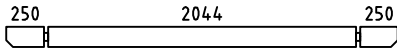
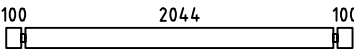
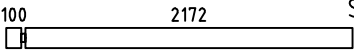
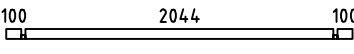
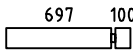
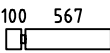
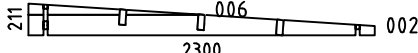
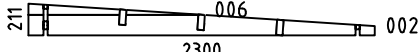

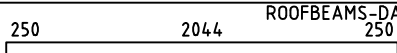

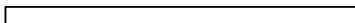



House	2813451	Sheet	4
Drawing	WALL - WAND - MUUR B	Scale	1:35
Material	2.8x13.5	Date	21.08.2025
Drawer	K.K.	File	2813451.dwg

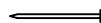

House	2813451	Sheet	5
Drawing	WALL-WAND-MUUR 1	Scale	1:35
Material	2.8x13.5	Date	21.08.2025
Drawer	K.K.	File	2813451.dwg



Pos	Specification-Bestimmung-Omschrijving	Pcs	Profile (mm)	L (mm)		
001	 PM	2	28x135	2600		
003		38	28x135	2300		
004	 SPARE BEAM-ERZATZBOHLE-VOORRAADPLANK	1	28x135	2300		
005		2	28x68	2300		
007		10	28x135	825		
008		28	28x135	695		
WA-1		1	28x211	2300		
WB-1		1	28x211	2300		
HB	HIT BLOCK-SCHLAGHÖLZER-BLAZENPLANK 	2	28x135	300		
RB1	 ROOFBEAMS-DACHBALKEN-DAKBALK	3	43x140	2600		
R1	ROOFBOARD-DACHBRETT-DAKPLANK  or-oder-of	30+1 23+1	18x88 18x114	2560		
FF1	FLOOR FILLET-FUSSBODENLEISTE-BAGUETTE DE FINITION DE PLANCHER 		18x35	8.5		
GB1	GABLE BOARD-GIEBELBLENDE-GEVELPLANK 	2	18x120	2610		
GS1	ROOF FELT FILLET-GIEBELLEISTE-GEVELLIJST 	3	18x70	2600		
EB1	EAVE BOARD-TRAUFBRETT-AFDEKPLANK 	2	18x90	2600		
ES1	EAVE SLAT-TRAUFENLEISTE-AFDEKLIJST 	2	30x40	2600		
SS1	STORM SLAT-STURMLEISTE-STORMLIJST 	2	35x18	2050		
SS2	STORM SLAT-STURMLEISTE-STORMLIJST 	2	35x18	1950		
	SCREWS-SCHRAUBEN-SCHROEF FOR-FÜR-VOOR SS1 	12	φ6.0	45		
	WASHER-SCHEIBE-SCHIJF FOR-FÜR-VOOR SS1 	12	φ6.0	18		
	NAIL-NAGEL-NAGEL FOR-FÜR-VOOR R1 	160	φ2.5	60		
	SCREWS-SCHRAUBEN-SCHROEF FOR-FÜR-VOOR GB1, GS1, EB1, ES1 	70	φ4.5	50		
	SCREWS-SCHRAUBEN-VIS 2x005 FOR-FÜR-POUR 	10	φ4.5	90		
	SCREWS-SCHRAUBEN-SCHROEF FOR-FÜR-VOOR RB1 	6	φ6.0	160		
Kood	2813451	Materjal	File	2813451.dwg	Leht	7

